

**Honeywell**

# **Xenon™ 1900/1902**

---

Area-Imaging Scanner

## **User's Guide**

---

## ***Disclaimer***

Honeywell International Inc. ("HII") reserves the right to make changes in specifications and other information contained in this document without prior notice, and the reader should in all cases consult HII to determine whether any such changes have been made. The information in this publication does not represent a commitment on the part of HII.

HII shall not be liable for technical or editorial errors or omissions contained herein; nor for incidental or consequential damages resulting from the furnishing, performance, or use of this material.

This document contains proprietary information that is protected by copyright. All rights are reserved. No part of this document may be photocopied, reproduced, or translated into another language without the prior written consent of HII.

© 2010-2012 Honeywell International Inc. All rights reserved.

Web Address: [www.honeywellaidc.com](http://www.honeywellaidc.com)

Xenon is a trademark or registered trademark of Honeywell International Inc.

Microsoft® Windows®, Windows NT®, Windows 2000, Windows ME, Windows XP, and the Windows logo are trademarks or registered trademarks of Microsoft Corporation.

The Bluetooth® word mark and logos are owned by Bluetooth SIG, Inc.

Other product names or marks mentioned in this document may be trademarks or registered trademarks of other companies and are the property of their respective owners.

---

---

# ***Product Agency Compliance - Xenon 1900***

## ***USA***

### ***FCC Part 15 Subpart B Class B***

This device complies with part 15 of the FCC Rules. Operation is subject to the following two conditions:

1. This device may not cause harmful interference.
2. This device must accept any interference received, including interference that may cause undesired operation.

This equipment has been tested and found to comply with the limits for a Class B digital device pursuant to part 15 of the FCC Rules. These limits are designed to provide reasonable protection against harmful interference in a residential installation. This equipment generates, uses, and can radiate radio frequency energy and, if not installed and used in accordance with the instructions, may cause harmful interference to radio communications. However, there is no guarantee that interference will not occur in a particular installation. If this equipment does cause harmful interference to radio or television reception, which can be determined by turning the equipment off and on, the user is encouraged to try to correct the interference by one or more of the following measures:

- Reorient or relocate the receiving antenna.
- Increase the separation between the equipment and receiver.
- Connect the equipment into an outlet on a circuit different from that to which the receiver is connected.
- Consult the dealer or an experienced radio or television technician for help.

If necessary, the user should consult the dealer or an experienced radio/television technician for additional suggestions. The user may find the following booklet helpful: "Something About Interference." This is available at FCC local regional offices. Honeywell is not responsible for any radio or television interference caused by unauthorized modifications of this equipment or the substitution or attachment of connecting cables and equipment other than those specified by Honeywell. The correction is the responsibility of the user.

Use only shielded data cables with this system. This unit has been tested with cables less than 3 meters. Cables greater than 3 meters may not meet class B performance.

Caution: Any changes or modifications made to this equipment not expressly approved by Honeywell may void the FCC authorization to operate this equipment.

### ***UL Statement***

UL listed: UL60950-1, 2nd Edition.

---

## Canada

### **Industry Canada ICES-003**

This Class B digital apparatus complies with Canadian ICES-003. Operation is subject to the following conditions:

1. This device may not cause harmful interference.
2. This device must accept any interference received, including interference that may cause undesired operation.

### **Conformité à la réglementation canadienne**

Cet appareil numérique de la Classe A est conforme à la norme NMB-003 du Canada. Son fonctionnement est assujéti aux conditions suivantes :

1. Cet appareil ne doit pas causer de brouillage préjudiciable.
2. Cet appareil doit pouvoir accepter tout brouillage reçu, y compris le brouillage pouvant causer un fonctionnement indésirable.



**C-UL Statement**

C-UL listed: CSA C22.2 No.60950-1-07, 2nd Edition.

## Europe



The CE marking indicates compliance to 2004/108/EC EMC Directive with Standards EN55022 CLASS B, EN55024, EN61000-3-2, EN61000-3-3. In addition, complies to 2006/95/EC Low Voltage Directive, when shipped with recommended power supply.

For further information please contact:

Honeywell Imaging & Mobility Europe BV  
Nijverheidsweg 9-13  
5627 BT Eindhoven  
The Netherlands

Honeywell International Inc. shall not be liable for use of our product with equipment (i.e., power supplies, personal computers, etc.) that is not CE marked and does not comply with the Low Voltage Directive.

### **Waste Electrical and Electronic Equipment Information**

Honeywell complies with Directive 2002/96/EC OF THE EUROPEAN PARLIAMENT AND OF THE COUNCIL of 27 January 2003 on waste electrical and electronic equipment (WEEE).

---

This product has required the extraction and use of natural resources for its production. It may contain hazardous substances that could impact health and the environment, if not properly disposed.

In order to avoid the dissemination of those substances in our environment and to diminish the pressure on the natural resources, we encourage you to use the appropriate take-back systems for product disposal. Those systems will reuse or recycle most of the materials of the product you are disposing in a sound way.



The crossed out wheeled bin symbol informs you that the product should not be disposed of along with municipal waste and invites you to use the appropriate separate take-back systems for product disposal.

If you need more information on the collection, reuse, and recycling systems, please contact your local or regional waste administration.

You may also contact your supplier for more information on the environmental performances of this product.

## **Germany**



If your product is marked with the GS symbol, then the product has been issued a GS certificate showing compliance to EN 60950-1, Second Edition.

This device is not intended for use in direct field of view at visual display workplaces. To avoid distracting reflections at visual display workplaces, this device should not be placed in direct field of view.

## **Australia/NZ**

### **C-Tick Statement**



Conforms to AS/NZS 3548 EMC requirement

## **Mexico**



Conforms to NOM-019.

## **Japan**



---

## **Russia**



Gost-R certificate

## **South Korea**



This product meets Korean agency approval.

## **Taiwan**

If the following label is attached to your product, the product meets Taiwan agency approval:



BSMI Standard: CNS13438, CNS14336

依據標準 : CNS13438, CNS14336

## **International**

### **LED Safety Statement**

LEDs have been tested and classified as “EXEMPT RISK GROUP” to the standard: IEC 62471:2006.

### **CB Scheme**

Certified to CB Scheme IEC 60950-1, Second Edition.

### **Laser Safety Statement**

If the following label is attached to your product, it indicates the product contains a laser engine or laser aimer:

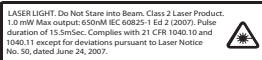

This device has been tested in accordance with and complies with IEC60825-1 ed2 (2007) Pulse duration of 15.5 mSec. Complies with 21 CFR 1040.10 and 1040.11 except for deviations pursuant to Laser Notice No. 50, dated June 24, 2007.

LASER LIGHT, DO NOT STARE INTO BEAM, CLASS 2 LASER PRODUCT, 1.0 mW MAX OUTPUT: 650nm.

---

**Caution: Use of controls or adjustments or performance of procedures other than those specified herein may result in hazardous radiation exposure.**

## ***Patents***

For patent information, please refer to [www.honeywellaidc.com/patents](http://www.honeywellaidc.com/patents).

## ***Solids and Water Protection***

The Xenon 1900 has a rating of IP41, immunity of foreign particles and dripping water.

## ***Warning***



To reduce the possibility of heat-related injuries, avoid touching sections of the scanner that feel warm.

---

# **Product Agency Compliance - Xenon 1902 and CCB01-010BT Base**

## **USA**

### **FCC Part 15 Subpart C**

This device complies with part 15 of the FCC Rules. Operation is subject to the following two conditions:

1. This device may not cause harmful interference.
2. This device must accept any interference received, including interference that may cause undesired operation.

Caution: Any changes or modifications made to this equipment not expressly approved by Honeywell may void the FCC authorization to operate this equipment.

Use only shielded data cables with this system. This unit has been tested with cables less than 3 meters. Cables greater than 3 meters may not meet class B performance.



UL listed: UL60950-1, 2nd Edition..

## **Canada**

### **Industry Canada**

This device complies with Canadian RSS-210. Operation is subject to the following conditions:

1. This device may not cause interference.
2. This device must accept any interference, including interference that may cause undesired operation.

### **Conformité à la réglementation canadienne**

Cet appareil ISM est conforme à la norme CNR-210 du Canada. Son fonctionnement est assujéti aux conditions suivantes :

1. Cet appareil ne doit pas causer de brouillage préjudiciable.
2. Cet appareil doit pouvoir accepter tout brouillage reçu, y compris le brouillage pouvant causer un fonctionnement indésirable.





C-UL listed: CSA C22.2 No.60950-1-07, 2nd Edition for I.T.E. product safety.

## Europe

**CE** The CE marking on the product indicates that this device is in conformity with all essential requirements of the 1999/5/EC R&TTE Directive. In addition, complies to 2006/95/EC Low Voltage Directive, when shipped with recommended power supply. For further information, contact:

Honeywell Imaging & Mobility Europe BV  
International Inc.  
Nijverheidsweg 9-13  
5627 BT Eindhoven  
The Netherlands

Honeywell shall not be liable for use of our product with equipment (i.e., power supplies, personal computers, etc.) that is not CE marked and does not comply with the Low Voltage Directive. This equipment is intended for use throughout the European Community and has been assessed to the following standards:

EN 300 328

EN 301 489-1

EN 301 489-17

EN60950-1

## **Waste Electrical and Electronic Equipment Information**

Honeywell complies with Directive 2002/96/EC OF THE EUROPEAN PARLIAMENT AND OF THE COUNCIL on waste electrical and electronic equipment (WEEE).

This product has required the extraction and use of natural resources for its production. It may contain hazardous substances that could impact health and the environment, if not properly disposed.

In order to avoid the dissemination of those substances in our environment and to diminish the pressure on the natural resources, we encourage you to use the appropriate take-back systems for product disposal. Those systems will reuse or recycle most of the materials of the product you are disposing in a sound way.



The crossed out wheeled bin symbol informs you that the product should not be disposed of along with municipal waste and invites you to use the appropriate separate take-back systems for product disposal.

If you need more information on the collection, reuse, and recycling systems, contact your local or regional waste administration.

You may also contact your supplier for more information on the environmental performances of this product.

## Germany



If your product is marked with the GS symbol, then the product has been issued a GS certificate showing compliance to EN 60950-1, Second Edition.

This device is not intended for use in direct field of view at visual display workplaces. To avoid distracting reflections at visual display workplaces, this device should not be placed in direct field of view.

## Australia/NZ

### C-Tick Statement



Conforms to AS/NZS 3548 EMC requirements.

## Brazil

This product is approved by Anatel, according to the procedures regulated by Resolution No. 242/2000 and meets the technical requirements applied.

Este produto está homologado pela ANATEL, de acordo com os procedimentos regulamentados pela Resolução No. 242/2000 e atende aos requisitos técnicos aplicados.

Para maiores informações, consulte o site da ANATEL – [www.anatel.gov.br](http://www.anatel.gov.br)



## China

SRRC Radio Certificate.

---

## **Japan**



Complies with Technical Regulations Conformity Certification of Specified Radio equipment.

## **Korea**



This product meets Korean agency approval.

## **Mexico**



Conforms to NOM-019.

This product meets Cofetel approval.

## **Russia**



Gost-R certificate.

## **Taiwan**

If the following label is attached to your product, the product meets Taiwan agency approval:



BSMI Standard: CNS13438, CNS14336 (Xenon 1902 only)

依據標準 : CNS13438, CNS14336



NCC standard: Low power frequency electric machineries technical standard: LP0002

---

# International

## LED Safety Statement

Scanner LEDs have been tested and classified as “EXEMPT RISK GROUP” to the standard: IEC 62471:2006.

## Radio Technology



## CB Scheme

Certified to CB Scheme IEC 60950-1, Second Edition.

## Laser Safety Statement

If the following label is attached to your product, it indicates the product contains a laser engine or laser aimer:

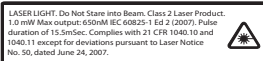

This device has been tested in accordance with and complies with IEC60825-1 ed2 (2007) Pulse duration of 15.5 mSec. Complies with 21 CFR 1040.10 and 1040.11, except for deviations pursuant to Laser Notice No. 50, dated June 24, 2007.

LASER LIGHT, DO NOT STARE INTO BEAM, CLASS 2 LASER PRODUCT, 1.0 mW MAX OUTPUT: 650nm.

**Caution: Use of controls or adjustments or performance of procedures other than those specified herein may result in hazardous radiation exposure.**

## Solids and Water Protection

The Xenon 1902 has a rating of IP41, immunity of foreign particles and dripping water.

## Patents

For patent information, please refer to [www.honeywellaidc.com/patents](http://www.honeywellaidc.com/patents).

## Warning



To reduce the possibility of heat-related injuries, avoid touching sections of the scanner that feel warm.

---

## ***Required Safety Labels*** ***Scanner***

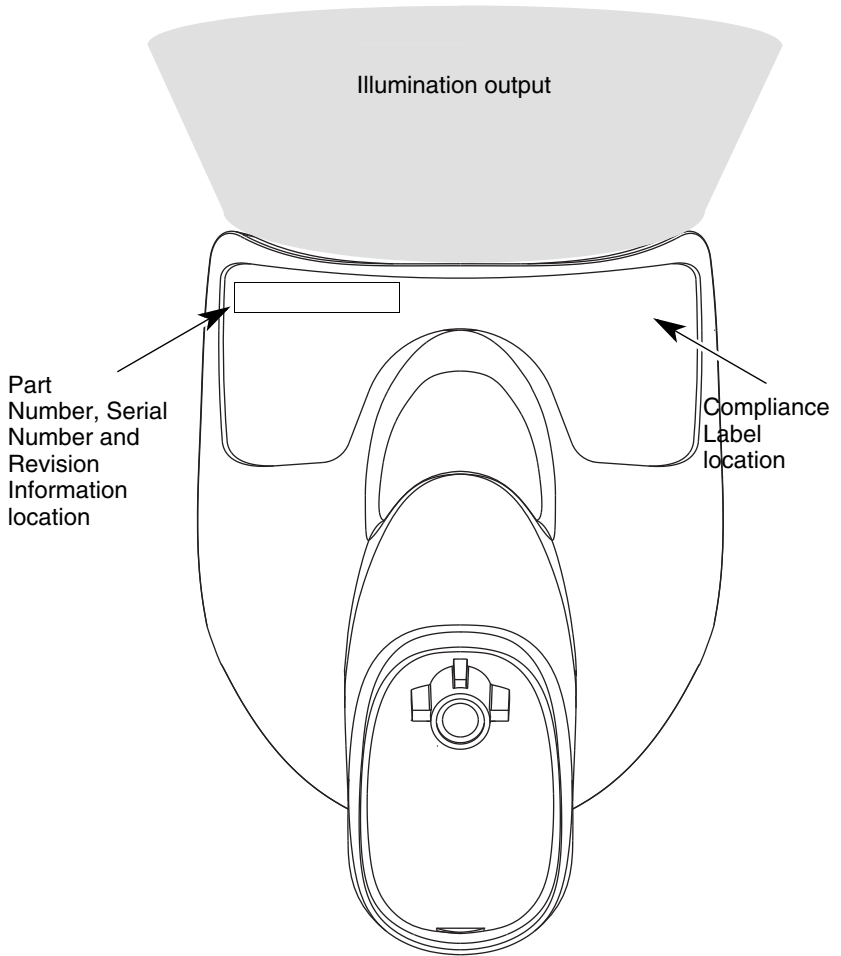

# CCB01-010BT Base

Part Number,  
Serial  
Number and  
Revision  
Information  
location

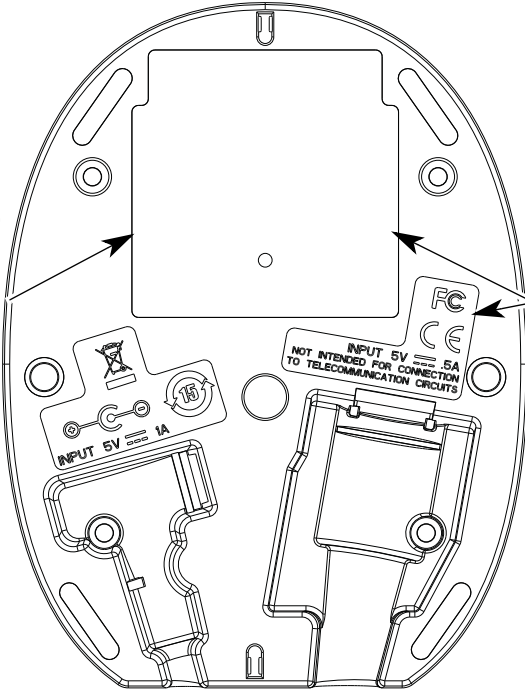

Compliance  
Label  
locations



# Table of Contents

## Chapter 1 - Getting Started

About This Manual .....	1-1
Unpacking Your Device.....	1-1
Connecting the Device .....	1-2
Connecting with USB .....	1-2
Connecting with Keyboard Wedge .....	1-3
Connecting with RS232 Serial Port .....	1-5
Connecting with RS485.....	1-7
Reading Techniques .....	1-9
Menu Bar Code Security Settings .....	1-10
Setting Custom Defaults .....	1-10
Resetting the Custom Defaults .....	1-11
Resetting the Factory Defaults.....	1-11

## Chapter 2 - Programming the Interface

Introduction .....	2-1
Programming the Interface - Plug and Play .....	2-1
Keyboard Wedge .....	2-1
Laptop Direct Connect .....	2-1
RS232 Serial Port .....	2-2
RS485 .....	2-2
RS485 Packet Mode .....	2-3
USB IBM SurePos.....	2-4
USB PC or Macintosh Keyboard.....	2-4
USB HID.....	2-5
USB Serial.....	2-5
CTS/RTS Emulation .....	2-5
ACK/NAK Mode.....	2-5
Verifone® Ruby Terminal Default Settings .....	2-6
Gilbarco® Terminal Default Settings .....	2-6
Honeywell Bioptic Aux Port Configuration.....	2-7
Datalogic™ Magellan® Bioptic Aux Port Configuration.....	2-7
NCR Bioptic Aux Port Configuration .....	2-7

---

Wincor Nixdorf Terminal Default Settings .....	2-8
Wincor Nixdorf Beetle™ Terminal Default Settings .....	2-8
Keyboard Country Layout .....	2-9
Keyboard Style .....	2-15
Keyboard Conversion .....	2-17
Control Character Output.....	2-17
Keyboard Modifiers.....	2-18
RS232 Baud Rate.....	2-20
RS232 Word Length: Data Bits, Stop Bits, and Parity .....	2-21
RS232 Receiver Time-Out.....	2-22
RS232 Handshaking.....	2-22
RS232 Timeout.....	2-23
XON/XOFF .....	2-23
ACK/NAK .....	2-23
Scanner to Bioptic Communication.....	2-24
Scanner-Biopic Packet Mode .....	2-24
Scanner-Biopic ACK/NAK Mode.....	2-25
Scanner-Biopic ACK/NAK Timeout.....	2-25

### **Chapter 3 - Cordless System Operation**

How the Cordless Charge Base/ Access Point Works .....	3-1
Linking the Scanner to a Charge Base .....	3-1
Linking the Scanner to an Access Point .....	3-2
Communication Between the Cordless System and the Host.....	3-2
RF (Radio Frequency) Module Operation.....	3-3
System Conditions.....	3-3
Linking Process .....	3-3
Scanner Is Out of Range .....	3-4
Scanner Is Moved Back Into Range .....	3-4
Out of Range and Back into Range with Batch Mode On .....	3-4
Page Button.....	3-4
About the Battery .....	3-4



---

Charging Information.....	3-5
Battery Recommendations .....	3-5
Proper Disposal of the Battery .....	3-6
Beeper and LED Sequences and Meaning.....	3-6
Scanner LED Sequences and Meaning .....	3-7
Base/Access Point LED Sequences and Meaning .....	3-7
Base Power Communication Indicator .....	3-8
Reset Scanner .....	3-8
Scanning While in Base Cradle.....	3-8
Paging .....	3-9
Paging Mode .....	3-9
Paging Pitch .....	3-10
Error Indicators.....	3-10
Beeper Pitch - Base Error .....	3-10
Number of Beeps - Base Error .....	3-10
Scanner Report .....	3-11
Scanner Address.....	3-11
Base or Access Point Address.....	3-11
Scanner Modes .....	3-12
Charge Only Mode .....	3-12
Linked Modes .....	3-12
Unlinking the Scanner .....	3-13
Override Locked Scanner.....	3-14
Out-of-Range Alarm .....	3-14
Alarm Sound Type.....	3-14
Scanner Power Time-Out Timer .....	3-15
Flexible Power Management.....	3-17
Batch Mode .....	3-18
Batch Mode Beep.....	3-19
Batch Mode Storage.....	3-19
Batch Mode Quantity.....	3-20
Batch Mode Output Order .....	3-23
Total Records .....	3-23
Delete Last Code.....	3-23
Clear All Codes .....	3-23
Transmit Records to Host.....	3-24

---

Batch Mode Transmit Delay .....	3-24
Multiple Scanner Operation .....	3-24
Scanner Name .....	3-25
Application Work Groups .....	3-27
Application Work Group Selection .....	3-28
Resetting the Factory Defaults:	
All Application Work Groups.....	3-28
Resetting the Custom Defaults:	
All Application Work Groups.....	3-29
Using the Scanner with Bluetooth Devices .....	3-29
Bluetooth HID Keyboard Connect.....	3-29
Bluetooth HID Keyboard Disconnect .....	3-32
Bluetooth Serial Port - PCs/Laptops .....	3-32
PDAs/Mobility Systems Devices .....	3-32
Changing the Scanner's Bluetooth PIN Code.....	3-33
Minimizing Bluetooth/ISM Band Network Activity .....	3-33
Auto Reconnect Mode .....	3-33
Maximum Link Attempts .....	3-34
Relink Time-Out.....	3-35
Bluetooth/ISM Network Activity Examples .....	3-35
Host Command Acknowledgment .....	3-36

## ***Chapter 4 - Input/Output Settings***

Power Up Beeper .....	4-1
Beep on BEL Character.....	4-1
Trigger Click.....	4-2
Good Read and Error Indicators.....	4-2
Beeper – Good Read.....	4-2
Beeper Volume – Good Read.....	4-3
Beeper Pitch – Good Read.....	4-3
Beeper Pitch – Error .....	4-4
Beeper Duration – Good Read .....	4-4
LED – Good Read .....	4-4
Number of Beeps – Good Read .....	4-5
Number of Beeps – Error.....	4-5
Good Read Delay .....	4-6

---

User-Specified Good Read Delay .....	4-6
Manual Trigger Modes .....	4-6
LED Illumination - Manual Trigger.....	4-7
Serial Trigger Mode.....	4-7
Read Time-Out.....	4-7
Presentation Mode .....	4-8
LED Illumination - Presentation Mode.....	4-9
Presentation LED Behavior after Decode .....	4-9
Presentation Sensitivity .....	4-10
Presentation Centering.....	4-10
In-Stand Sensor Mode .....	4-12
CodeGate® .....	4-13
Streaming Presentation™ Mode .....	4-13
Streaming Presentation In-Stand Programming..	4-14
Mobile Phone Read Mode.....	4-14
Image Snap and Ship.....	4-15
Hands Free Time-Out .....	4-15
Reread Delay .....	4-15
User-Specified Reread Delay.....	4-16
Illumination Lights .....	4-16
Aimer Delay.....	4-17
User-Specified Aimer Delay .....	4-17
Scanner Time-Out.....	4-17
Aimer Mode .....	4-18
Centering.....	4-18
Preferred Symbology .....	4-20
High Priority Symbology .....	4-21
Low Priority Symbology.....	4-21
Preferred Symbology Time-out .....	4-21
Preferred Symbology Default .....	4-22
Output Sequence Overview .....	4-22
Require Output Sequence.....	4-22
Output Sequence Editor.....	4-22
To Add an Output Sequence.....	4-23
Other Programming Selections .....	4-23
Output Sequence Editor .....	4-25
Partial Sequence .....	4-25

---

---

Require Output Sequence .....	4-26
Multiple Symbols.....	4-26
No Read.....	4-27
Video Reverse .....	4-27
Working Orientation .....	4-28

## **Chapter 5 - Data Editing**

Prefix/Suffix Overview.....	5-1
To Add a Prefix or Suffix:.....	5-1
To Clear One or All Prefixes or Suffixes .....	5-2
To Add a Carriage Return Suffix to All Symbolologies.....	5-3
Prefix Selections .....	5-3
Suffix Selections .....	5-4
Function Code Transmit .....	5-4
Intercharacter, Interfunction, and Intermessage Delays.....	5-4
Intercharacter Delay .....	5-5
User Specified Intercharacter Delay .....	5-5
Interfunction Delay .....	5-6
Intermessage Delay .....	5-6

## **Chapter 6 - Data Formatting**

Data Format Editor Introduction.....	6-1
Add a Data Format .....	6-1
Other Programming Selections.....	6-3
Terminal ID Table .....	6-4
Data Format Editor Commands .....	6-4
Move Commands.....	6-6
Search Commands .....	6-6
Miscellaneous Commands.....	6-8
Data Formatter.....	6-9
Data Format Non-Match Error Tone .....	6-10
Primary/Alternate Data Formats .....	6-11
Single Scan Data Format Change .....	6-11

---

## **Chapter 7 - Symbologies**

All Symbologies.....	7-2
Message Length Description.....	7-2
Codabar .....	7-3
Codabar Concatenation .....	7-4
Code 39.....	7-6
Code 32 Pharmaceutical (PARAF).....	7-8
Full ASCII .....	7-9
Code 39 Code Page.....	7-9
Interleaved 2 of 5 .....	7-10
NEC 2 of 5.....	7-12
Code 93.....	7-14
Code 93 Code Page.....	7-15
Straight 2 of 5 Industrial (three-bar start/stop) .....	7-16
Straight 2 of 5 IATA (two-bar start/stop).....	7-17
Matrix 2 of 5 .....	7-18
Code 11.....	7-19
Code 128.....	7-20
ISBT 128 Concatenation .....	7-20
Code 128 Code Page.....	7-22
GS1-128.....	7-23
Telepen .....	7-24
UPC-A .....	7-25
UPC-A/EAN-13	
with Extended Coupon Code .....	7-27
Coupon GS1 DataBar Output .....	7-28
UPC-E0 .....	7-28
UPC-E1 .....	7-31
EAN/JAN-13.....	7-31
ISBN Translate .....	7-33
EAN/JAN-8.....	7-34
MSI .....	7-36
GS1 DataBar Omnidirectional.....	7-38
GS1 DataBar Limited .....	7-38
GS1 DataBar Expanded.....	7-39
Trioptic Code.....	7-40

---

Codablock A .....	7-40
Codablock F.....	7-42
PDF417.....	7-43
MacroPDF417.....	7-44
MicroPDF417.....	7-44
GS1 Composite Codes .....	7-45
UPC/EAN Version.....	7-45
GS1 Emulation.....	7-46
TCIF Linked Code 39 (TLC39) .....	7-47
QR Code.....	7-48
QR Code Page .....	7-49
Data Matrix .....	7-50
Data Matrix Code Page .....	7-51
MaxiCode.....	7-52
Aztec Code .....	7-53
Aztec Code Page.....	7-54
Chinese Sensible (Han Xin) Code .....	7-55
Postal Codes - 2D.....	7-56
Single 2D Postal Codes:.....	7-56
Combination 2D Postal Codes:.....	7-57
Postal Codes - Linear .....	7-60
China Post (Hong Kong 2 of 5).....	7-60
Korea Post.....	7-62

## **Chapter 8 - Imaging Commands**

Single-Use Basis .....	8-1
Command Syntax .....	8-1
Image Snap - IMGSNP .....	8-2
IMGSNP Modifiers .....	8-2
Image Ship - IMGSHIP .....	8-5
IMGSHIP Modifiers .....	8-5
Intelligent Signature Capture - IMGBOX.....	8-14
Signature Capture Optimize .....	8-14
IMGBOX Modifiers.....	8-15
RF Default Imaging Device.....	8-19

---

## **Chapter 9 - Interface Keys**

Keyboard Function Relationships .....	9-1
Supported Interface Keys.....	9-3

## **Chapter 10 - Utilities**

To Add a Test Code I.D. Prefix to All Symbologies .....	10-1
Show Decoder Revision.....	10-1
Show Scan Driver Revision.....	10-1
Show Software Revision .....	10-1
Show Data Format .....	10-2
Test Menu .....	10-2
TotalFreedom.....	10-2
Application Plug-Ins (Apps).....	10-3
EZConfig-Scanning Introduction .....	10-3
Installing EZConfig-Scanning from the Web .....	10-4

## **Chapter 11 - Serial Programming Commands**

Conventions .....	11-1
Menu Command Syntax.....	11-1
Query Commands .....	11-2
Responses .....	11-3
Trigger Commands .....	11-4
Resetting the Custom Defaults .....	11-4
Menu Commands .....	11-5

## **Chapter 12 - Product Specifications**

1900/1910 Scanner Product Specifications .....	12-1
1902/1912 Scanner Product Specifications .....	12-2
CCB01-010BT Charge Base Product Specifications	12-3
Depth of Field Charts .....	12-5
CCB01-010BT Charge Base Mounting .....	12-8
Standard Cable Pinouts .....	12-9
Keyboard Wedge.....	12-9

---

Serial Output .....	12-10
RS485 Output .....	12-11
USB .....	12-12

### ***Chapter 13 - Maintenance***

Repairs .....	13-1
Maintenance .....	13-1
Cleaning the Scanner .....	13-1
Cleaning the Window .....	13-1
Health Care Housing .....	13-1
Inspecting Cords and Connectors .....	13-2
Replacing Cables in Corded Scanners .....	13-2
Replacing an Interface Cable .....	13-3
Replacing Cables and Batteries in Cordless Systems.....	13-3
Replacing an Interface Cable in a Base .....	13-3
Changing a scanner Battery .....	13-4
Troubleshooting a Xenon Scanner .....	13-4
Troubleshooting a Cordless System.....	13-5
Troubleshooting a Base.....	13-5
Troubleshooting a Cordless Scanner .....	13-6

### ***Chapter 14 - Customer Support***

Technical Assistance .....	14-1
----------------------------	------

### ***Appendix A - Reference Charts***

Symbology Chart .....	A-1
ASCII Conversion Chart (Code Page 1252) .....	A-4
Code Page Mapping of Printed Bar Codes.....	A-6
Unicode Key Maps.....	A-8



# Getting Started

## ***About This Manual***

This User's Guide provides installation and programming instructions for the Xenon™ 1900 and 1902 area-imaging scanners. Product specifications, dimensions, warranty, and customer support information are also included.

Honeywell bar code scanners are factory programmed for the most common terminal and communications settings. If you need to change these settings, programming is accomplished by scanning the bar codes in this guide.

An asterisk (\*) next to an option indicates the default setting.

## ***Unpacking Your Device***

After you open the shipping carton containing the product, take the following steps:

- Check for damage during shipment. Report damage immediately to the carrier who delivered the carton.
- Make sure the items in the carton match your order.
- Save the shipping container for later storage or shipping.

---

## Connecting the Device

### Connecting with USB

A scanner or a cordless base can be connected to the USB port of a computer.

1. Connect the appropriate interface cable to the device first, then to the computer.

#### **Corded Scanner USB Connection:**

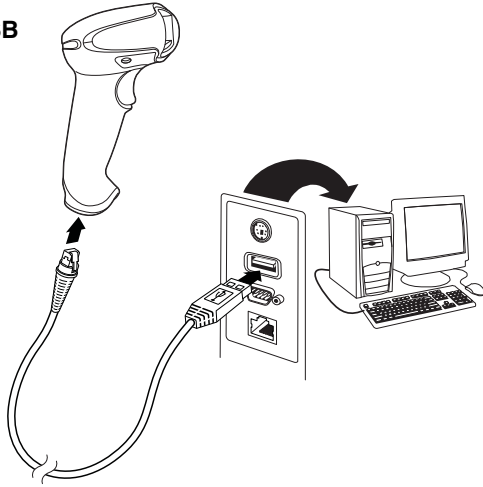

---

### Cordless Base USB Connection:

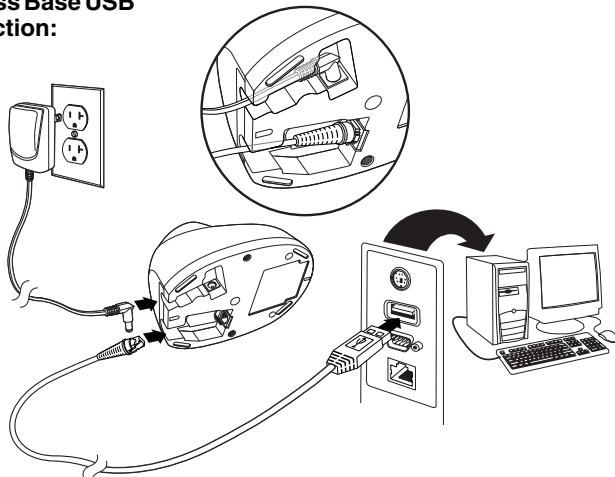

*Note: The power supply must be ordered separately, if needed.*

2. Make sure the cables are secured in the wireways in the bottom of the cordless base and that the base sits flat on a horizontal surface.
3. The scanner beeps.
4. Verify the scanner or cordless base operation by scanning a bar code from the [Sample Symbols](#) in the back of this manual.

The unit defaults to a USB PC Keyboard. Refer to [page 2-4](#) for other USB terminal settings.

For additional USB programming and technical information, refer to "USB Application Note," available at [www.honeywellaidc.com](http://www.honeywellaidc.com).

### **Connecting with Keyboard Wedge**

A scanner or cordless base can be connected between the keyboard and PC as a "keyboard wedge," where the scanner provides data output that is similar to keyboard entries. The following is an example of a keyboard wedge connection:

1. Turn off power and disconnect the keyboard cable from the back of the terminal/computer.

- 
2. Connect the appropriate interface cable to the device and to the terminal/computer.

**Corded Scanner  
Keyboard Wedge  
Connection:**

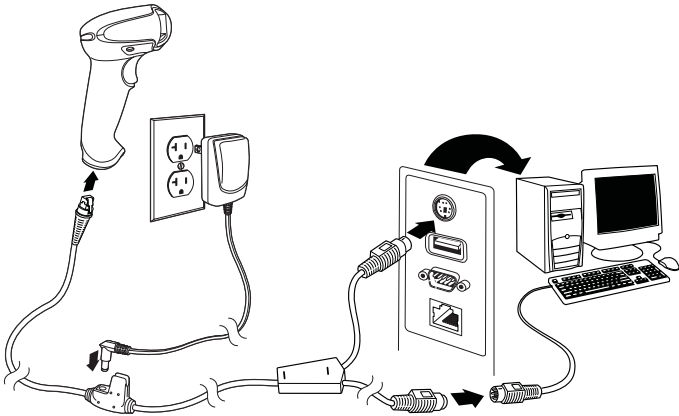

**Cordless Base  
Keyboard Wedge  
Connection:**

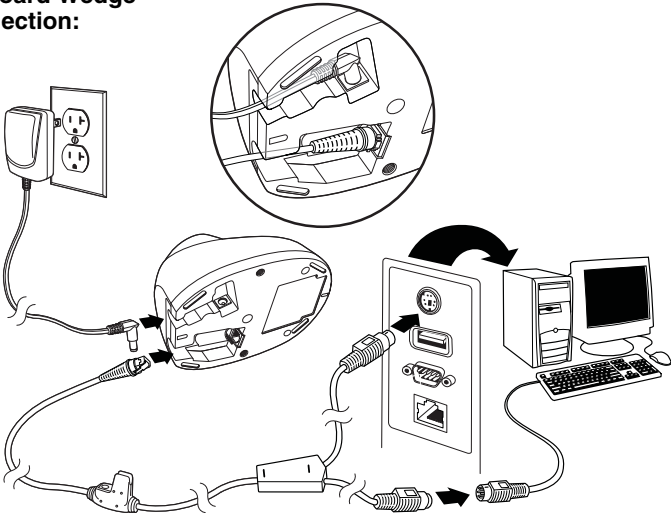

*Note: The power supply must be ordered separately, if needed.*

3. Make sure the cables are secured in the wireways in the bottom of the cordless base and that the base sits flat on a horizontal surface.
4. Turn the terminal/computer power back on. The scanner beeps.
5. Verify the scanner or cordless base operation by scanning a bar code from the [Sample Symbols](#) in the back of this manual. The scanner beeps once.

The unit defaults to an IBM PC AT and compatibles keyboard wedge interface with a USA keyboard. A carriage return (CR) suffix is added to bar code data.

### **Connecting with RS232 Serial Port**

1. Turn off power to the terminal/computer.
2. Connect the appropriate interface cable to the scanner.

*Note: For the scanner or cordless base to work properly, you must have the correct cable for your type of terminal/computer.*

#### **Corded Scanner RS232 Serial Port Connection:**

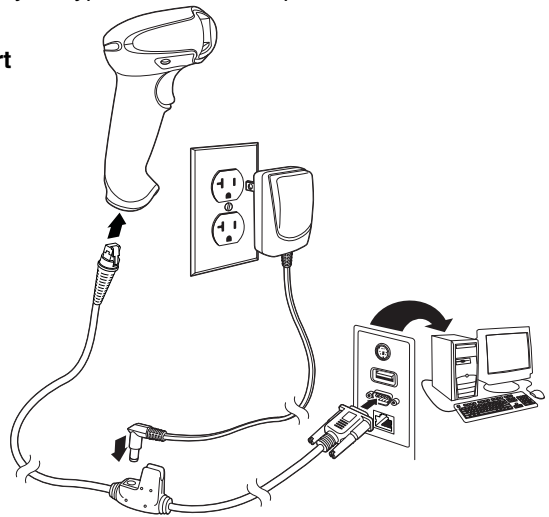

---

**Cordless Base  
RS232 Serial Port  
Connection:**

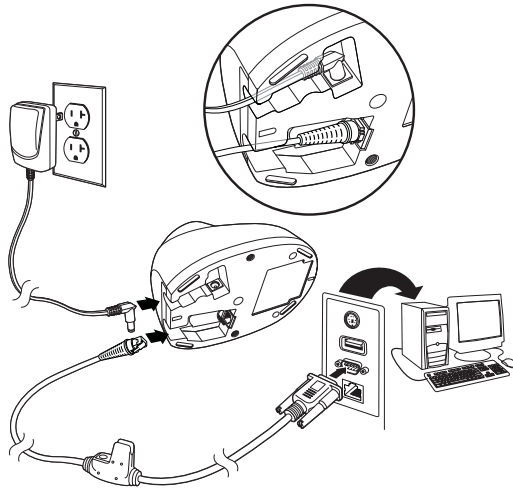

*Note: The power supply must be ordered separately, if needed.*

3. Make sure the cables are secured in the wireways in the bottom of the cordless base and that the base sits flat on a horizontal surface.
4. Plug the serial connector into the serial port on your computer. Tighten the two screws to secure the connector to the port.
5. Once the scanner or cordless base has been fully connected, power up the computer.

This interface programs 115,200 baud, 8 data bits, no parity, and 1 stop bit.

---

## Connecting with RS485

A scanner or cordless base can be connected for an IBM POS terminal interface.

1. Connect the appropriate interface cable to the device, then to the computer.

### **Corded Scanner RS485 Connection:**

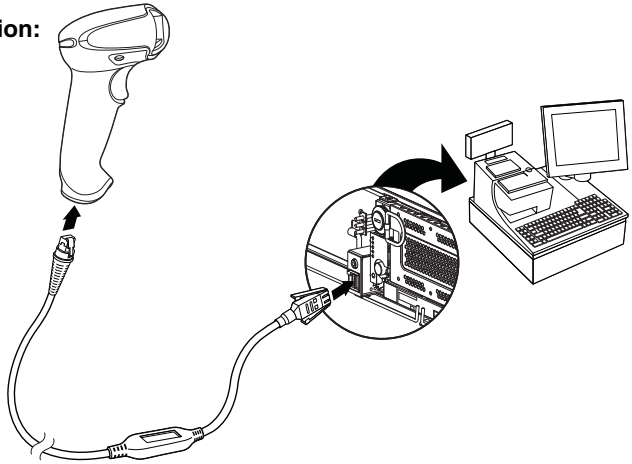

### **Cordless Base RS485 Connection:**

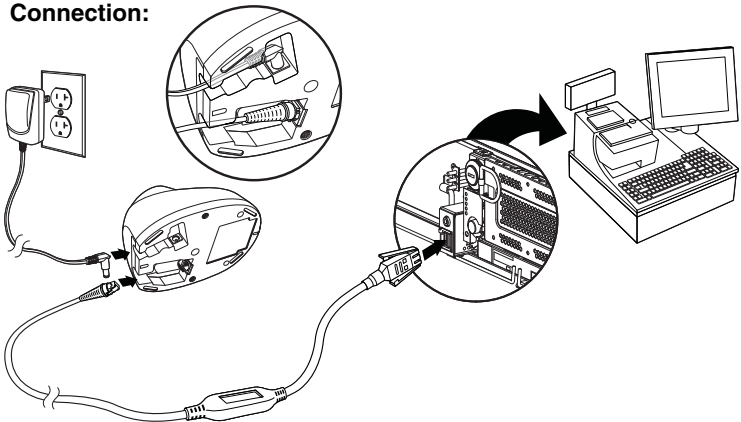

*Note: The power supply must be ordered separately, if needed.*

- 
2. Make sure the cables are secured in the wireways in the bottom of the cordless base and that the base sits flat on a horizontal surface.
  3. Turn the terminal/computer power back on. The scanner beeps.
  4. Verify the scanner or cordless base operation by scanning a bar code from the [Sample Symbols](#) in the back of this manual. The scanner beeps once.

For further RS485 settings, refer to [RS485](#), page 2-2.



---

## Reading Techniques

The Xenon 1900 and 1902 scanners have a view finder that projects a bright red aiming beam that corresponds to the scanner's horizontal field of view. The Xenon 1910 and 1912 scanners have an aiming pattern. The aiming beam or pattern should be centered over the bar code, but it can be positioned in any direction for a good read.

**Linear bar codes  
with aiming beam**

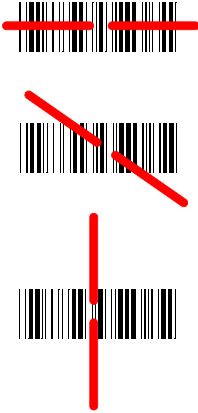

**Linear bar codes  
with aiming pattern**

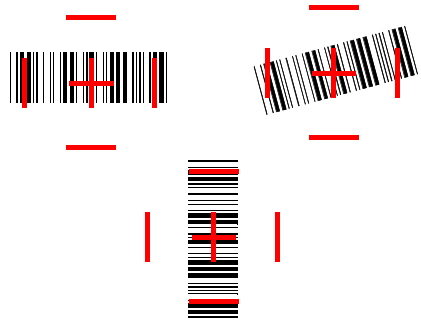

**2D Matrix symbol  
with aiming beam**

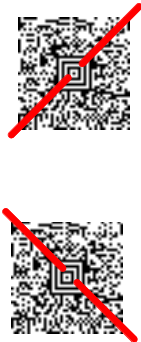

**2D Matrix symbol  
with aiming pattern**

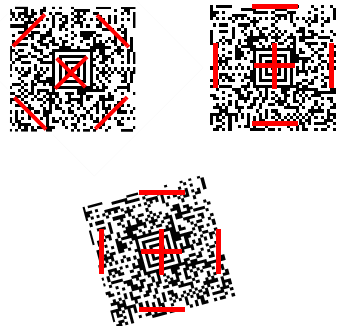

---

The aiming beam or pattern is smaller when the scanner is closer to the code and larger when it is farther from the code. Symbologies with smaller bars or elements (mil size) should be read closer to the unit. Symbologies with larger bars or elements (mil size) should be read farther from the unit. To read single or multiple symbols (on a page or on an object), hold the scanner at an appropriate distance from the target, pull the trigger, and center the aiming beam or pattern on the symbol. If the code being scanned is highly reflective (e.g., laminated), it may be necessary to tilt the code up 15° to 18° to prevent unwanted reflection.

## Menu Bar Code Security Settings

Honeywell scanners are programmed by scanning menu bar codes or by sending serial commands to the scanner. If you want to restrict the ability to scan menu codes, you can use the Menu Bar Code Security settings. Please contact the nearest technical support office (see [Technical Assistance](#) on page 14-1) for further information.

## Setting Custom Defaults

You have the ability to create a set of menu commands as your own, custom defaults. To do so, scan the **Set Custom Defaults** bar code below before scanning the menu commands for your custom defaults. If a menu command requires scanning numeric codes from the back cover, then a **Save** code, that entire sequence will be saved to your custom defaults. When you have entered all the commands you want to save for your custom defaults, scan the **Save Custom Defaults** bar code.



MNUCDP.

**Set Custom Defaults**



MNUCDS.

**Save Custom Defaults**

*Note: When using a cordless system, the Custom Defaults settings apply to all workgroups. Scanning the **Save Defaults** bar code also causes both the scanner and the base or Access Point to perform a reset and become unlinked. The scanner must be placed in its base to re-establish the link before any setup codes are entered. If using an Access Point, the linking bar code must be scanned. See [Cordless System Operation](#) beginning on page 3-1 for additional information.*

You may have a series of custom settings and want to correct a single setting. To do so, just scan the new setting to overwrite the old one. For example, if you had previously saved the setting for Beeper Volume at Low to your custom defaults, and decide you want the beeper volume set to High, just scan the **Set Custom Defaults** bar code, then scan the Beeper Volume High menu code, and then **Save Custom Defaults**. The rest of the custom defaults will remain, but the beeper volume setting will be updated.

---

## Resetting the Custom Defaults

If you want the custom default settings restored to your scanner, scan the **Activate Custom Defaults** bar code below. This is the recommended default bar code for most users. It resets the scanner to the custom default settings. If there are no custom defaults, it will reset the scanner to the factory default settings. Any settings that have not been specified through the custom defaults will be defaulted to the factory default settings.



DEFAULT.

**Activate Custom Defaults**

*Note: If using a cordless system, scanning this bar code also causes both the scanner and the base or Access Point to perform a reset and become unlinked. The scanner must be placed in its base to re-establish the link. If using an Access Point, the linking bar code must be scanned. See [Cordless System Operation](#) beginning on page 3-1 for additional information.*

## Resetting the Factory Defaults



*This selection erases all your settings and resets the scanner to the original factory defaults. It also disables all plugins.*

If you aren't sure what programming options are in your scanner, or you've changed some options and want to restore the scanner to factory default settings, first scan the **Remove Custom Defaults** bar code, then scan **Activate Defaults**. This resets the scanner to the factory default settings.



DEFOVR.

**Remove Custom Defaults**



DEFAULT.

**Activate Defaults**

*Note: If using a cordless system, scanning the **Activate Defaults** bar code also causes both the scanner and the base or Access Point to perform a reset and become unlinked. The scanner must be placed in its base to re-establish the link before any setup codes are entered. If using an Access Point, the linking bar code must be scanned. See [Cordless System Operation](#) beginning on page 3-1 for additional information.*

The [Menu Commands](#), beginning on page 11-5 list the factory default settings for each of the commands (indicated by an asterisk (\*) on the programming pages).



## Introduction

This chapter describes how to program your system for the desired interface.

## Programming the Interface - Plug and Play

Plug and Play bar codes provide instant scanner set up for commonly used interfaces.

*Note: After you scan one of the codes, power cycle the host terminal to have the interface in effect.*

## Keyboard Wedge

If you want your system programmed for an IBM PC AT and compatibles keyboard wedge interface with a USA keyboard, scan the bar code below. Keyboard wedge is the default interface.

*Note: The following bar code also programs a carriage return (CR) suffix.*



P AP \_AT.

IBM PC AT and Compatibles with  
CR suffix

## Laptop Direct Connect

For most laptops, scanning the **Laptop Direct Connect** bar code allows operation of the scanner in parallel with the integral keyboard. The following **Laptop Direct Connect** bar code also programs a carriage return (CR) suffix and turns on Emulate External Keyboard ([page 2-17](#)).



P AP L T D.

Laptop Direct Connect  
with CR suffix

---

## RS232 Serial Port

The **RS232 Interface** bar code is used when connecting to the serial port of a PC or terminal. The following **RS232 Interface** bar code also programs a carriage return (CR) and a line feed (LF) suffix, baud rate, and data format as indicated below. It also changes the trigger mode to manual.

Option	Setting
Baud Rate	115,200 bps
Data Format	8 data bits, no parity bit, 1 stop bit



PAP232.  
RS232 Interface

## RS485

Scan one of the following “Plug and Play” codes to program the scanner for an IBM POS terminal interface.

*Note: After scanning one of these codes, you must power cycle the cash register.*



PAPP5B.  
IBM Port 5B Interface



PAPP17.  
IBM Port 17 Interface



PAP9B1.  
IBM Port 9B  
HHBCR-1 Interface



PAP9B2.  
IBM Port 9B  
HHBCR-2 Interface

Each bar code above also programs the following suffixes for each symbology:

Symbology	Suffix	Symbology	Suffix
EAN 8	0C	Code 39	00 0A 0B
EAN 13	16	Interleaved 2 of 5	00 0D 0B
UPC A	0D	Code 128 *	00 0A 0B
UPC E	0A	Code 128 **	00 18 0B
		MaxiCode	00 2F 0B

\* Suffixes programmed for Code 128 with IBM 4683 Port 5B, IBM 4683 Port 9B HHBCR-1, and IBM 4683 Port 17 Interfaces

\*\*Suffixes programmed for Code 128 with IBM 4683 Port 9 HHBCR-2 Interface

## RS485 Packet Mode

The following selection allows you to break up large bar code data into smaller packets on an IBM POS terminal. To break up large bar codes into small packets, scan the Packet Mode On bar code below. Scan the Packet Mode Off bar code if you want large bar code data to be sent to the host in a single chunk. *Default = Packet Mode Off.*



RTLPDF0.

\* Packet Mode Off



RTLPDF1.

Packet Mode On

## RS485 Packet Length

If you are using Packet mode, you can specify the size of the data "packet" that is sent to the host. Scan the **Packet Length** bar code, then then the packet size (from 20 - 256) from the [Programming Chart](#) inside the back cover of this manual, then **Save**. *Default = 40.*



RTLMPS.

Packet Length

---

## USB IBM SurePos

Scan one of the following “Plug and Play” codes to program the scanner for an IBM SurePos (USB handheld scanner) or IBM SurePos (USB tabletop scanner) interface.

*Note: After scanning one of these codes, you must power cycle the cash register.*



PAPSPH.

**USB IBM SurePos  
(USB Handheld Scanner)  
Interface**



PAPSPT.

**USB IBM SurePos  
(USB Tabletop Scanner)  
Interface**

Each bar code above also programs the following suffixes for each symbology:

Symbology	Suffix	Symbology	Suffix
EAN 8	0C	Code 39	00 0A 0B
EAN 13	16	Interleaved 2 of 5	00 0D 0B
UPC A	0D	Code 128	00 18 0B
UPC E	0A	Code 39	00 0A 0B

## USB PC or Macintosh Keyboard

Scan one of the following codes to program the scanner for USB PC Keyboard or USB Macintosh Keyboard. Scanning these codes also adds a CR suffix.



PAP124.

**USB Keyboard (PC)**



PAP125.

**USB Keyboard (Mac)**



TRMUSB134.

**USB Japanese Keyboard (PC)**



---

## USB HID

Scan the following code to program the scanner for USB HID bar code scanners.



PAP131.

**USB HID Bar Code Scanner**

## USB Serial

Scan the following code to program the scanner to emulate a regular RS232-based COM Port. If you are using a Microsoft® Windows® PC, you will need to download a driver from the Honeywell website ([www.honeywellaidc.com](http://www.honeywellaidc.com)). The driver will use the next available COM Port number. Apple® Macintosh computers recognize the scanner as a USB CDC class device and automatically uses a class driver.



TRMUSB130.

**USB Serial**

*Note: No extra configuration (e.g., baud rate) is necessary.*

### CTS/RTS Emulation



USBCTS1.

**CTS/RTS Emulation On**



USBCTS0.

**\* CTS/RTS Emulation Off**

### ACK/NAK Mode



USBACK1.

**ACK/NAK Mode On**



USBACK0.

**\* ACK/NAK Mode Off**

---

## **Verifone® Ruby Terminal Default Settings**

Scan the following Plug and Play code to program the scanner for a Verifone Ruby terminal. This bar code sets the baud rate to 1200 bps and the data format to 8 data bits, no parity bit, 1 stop bit. It also adds a line feed (LF) suffix and programs the following prefixes for each symbology:

<b>Symbology</b>	<b>Prefix</b>
UPC-A	A
UPC-E	A
EAN-8	FF
EAN-13	F



PAPRBY.

**Verifone Ruby Settings**

## **Gilbarco® Terminal Default Settings**

Scan the following Plug and Play code to program the scanner for a Gilbarco terminal. This bar code sets the baud rate to 2400 bps and the data format to 7 data bits, even parity, 2 stop bits. It also adds a carriage return (CR) suffix and programs the following prefixes for each symbology:

<b>Symbology</b>	<b>Prefix</b>
UPC-A	A
UPC-E	E0
EAN-8	FF
EAN-13	F



PAPGLB.

**Gilbarco Settings**

---

## **Honeywell Bioptic Aux Port Configuration**

Scan the following Plug and Play code to program the scanner for a Honeywell bioptic scanner auxiliary port configuration. This bar code sets the baud rate to 38400 bps and the data format to 8 data bits, no parity, 1 stop bit.



PAPBIO.

**Honeywell Bioptic Settings**

## **Datalogic™ Magellan® Bioptic Aux Port Configuration**

Scan the following Plug and Play code to program the scanner for a Datalogic Magellan bioptic scanner auxiliary port configuration. This bar code sets the baud rate to 9600 bps and the data format to 8 data bits, no parity, 1 stop bit.



PAPMAG.

**Datalogic Magellan Bioptic Settings**

## **NCR Bioptic Aux Port Configuration**

Scan the following Plug and Play code to program the scanner for an NCR bioptic scanner auxiliary port configuration. The following prefixes are programmed for each symbology:

<b>Symbology</b>	<b>Prefix</b>	<b>Symbology</b>	<b>Prefix</b>
UPC-A	A	Code 39	B1
UPC-E	E0	Interleaved 2 of 5	B2
EAN-8	FF	All other bar codes	B3
EAN-13	F		



PAPNCR.

**NCR Bioptic Settings**

---

## ***Wincor Nixdorf Terminal Default Settings***

Scan the following Plug and Play code to program the scanner for a Wincor Nixdorf terminal. This bar code sets the baud rate to 9600 bps and the data format to 8 data bits, no parity, 1 stop bit.



PAPW NX.

**Wincor Nixdorf Terminal Settings**

## ***Wincor Nixdorf Beetle™ Terminal Default Settings***

Scan the following Plug and Play code to program the scanner for a Wincor Nixdorf Beetle terminal. The following prefixes are programmed for each symbology:

<b>Symbology</b>	<b>Prefix</b>	<b>Symbology</b>	<b>Prefix</b>
Code 128	K	EAN-13	A
Code 93	L	GS1-128	P
Codabar	N	Interleaved 2 of 5	I
UPC-A	A0	Plessey	O
UPC-E	C	Straight 2 of 5 IATA	H
EAN-8	B	All other bar codes	M



PAPB TL.

**Wincor Nixdorf Beetle Settings**

---

## Keyboard Country Layout

Scan the appropriate country code below to program the keyboard layout for your country or language. As a general rule, the following characters are supported, but need special care for countries other than the United States:

@ | \$ # { } [ ] = / ' \ < > ~



KBDCTY0.

\* United States



KBDCTY88.

United States (Dvorak left)



KBDCTY30.

United States (International)



KBDCTY81.

Azeri (Cyrillic)



KBDCTY82.

Belarus



KBDCTY33.

Bosnia



KBDCTY87.

United States (Dvorak)



KBDCTY89.

United States (Dvorak right)



KBDCTY35.

Albania



KBDCTY80.

Azeri (Latin)



KBDCTY1.

Belgium



KBDCTY16.

Brazil

---

## Keyboard Country (continued)



KBDCTY52.  
Bulgaria (Cyrillic)



KBDCTY54.  
Canada (French legacy)



KBDCTY55.  
Canada (Multilingual)



KBDCTY15.  
Czech



KBDCTY39.  
Czech (QWERTY)



KBDCTY8.  
Denmark



KBDCTY59.  
Brazil (MS)



KBDCTY53.  
Bulgaria (Latin)



KBDCTY18.  
Canada (French)



KBDCTY32.  
Croatia



KBDCTY40.  
Czech (Programmers)



KBDCTY38.  
Czech (QWERTZ)



KBDCTY11.  
Dutch (Netherlands)

---

## **Keyboard Country (continued)**



KBDCTY83.  
**Faeroese**



KBDCTY3.  
**France**



KBDCTY4.  
**Germany**



KBDCTY64.  
**Greek (220 Latin)**



KBDCTY65.  
**Greek (319 Latin)**



KBDCTY63.  
**Greek (Latin)**



KBDCTY41.  
**Estonia**



KBDCTY2.  
**Finland**



KBDCTY84.  
**Gaelic**



KBDCTY17.  
**Greek**



KBDCTY61.  
**Greek (220)**



KBDCTY62.  
**Greek (319)**



KBDCTY66.  
**Greek (MS)**

---

## Keyboard Country (continued)



KBDCTY12.  
Hebrew



KBDCTY19.  
Hungary



KBDCTY73.  
Irish



KBDCTY5.  
Italy



KBDCTY78.  
Kazakh



KBDCTY14.  
Latin America



KBDCTY60.  
Greek (Polytonic)



KBDCTY50.  
Hungarian (101 key)



KBDCTY75.  
Iceland



KBDCTY56.  
Italian (142)



KBDCTY28.  
Japan ASCII



KBDCTY79.  
Kyrgyz (Cyrillic)



KBDCTY42.  
Latvia



---

## Keyboard Country (continued)



KBDCTY44.  
Lithuania



KBDCTY34.  
Macedonia



KBDCTY86.  
Mongolian (Cyrillic)



KBDCTY20.  
Poland



KBDCTY58.  
Polish (Programmers)



KBDCTY25.  
Romania



KBDCTY43.  
Latvia (QWERTY)



KBDCTY45.  
Lithuania (IBM)



KBDCTY74.  
Malta



KBDCTY9.  
Norway



KBDCTY57.  
Polish (214)



KBDCTY13.  
Portugal



KBDCTY26.  
Russia

---

## Keyboard Country (continued)



KBDCTY68.  
Russian (Typewriter)



KBDCTY37.  
Serbia (Cyrillic)



KBDCTY22.  
Slovakia



KBDCTY48.  
Slovakia (QWERTZ)



KBDCTY10.  
Spain



KBDCTY23.  
Sweden



KBDCTY67.  
Russian (MS)



KBDCTY21.  
SCS



KBDCTY36.  
Serbia (Latin)



KBDCTY49.  
Slovakia (QWERTY)



KBDCTY31.  
Slovenia



KBDCTY51.  
Spanish variation



KBDCTY29.  
Switzerland (French)

---

## Keyboard Country (continued)



KBDCTY85.  
Tatar



KBDCTY24.  
Turkey Q



KBDCTY7.  
United Kingdom



KBDCTY88.  
United States (Dvorak left)



KBDCTY30.  
United States (International)



KBDCTY6.  
Switzerland (German)



KBDCTY27.  
Turkey F



KBDCTY76.  
Ukrainian



KBDCTY89.  
United States (Dvorak right)



KBDCTY87.  
United States (Dvorak)



KBDCTY77.  
Uzbek (Cyrillic)

## Keyboard Style

This programs keyboard styles, such as Caps Lock and Shift Lock. If you have used [Keyboard Conversion](#) settings, they will override any of the following Keyboard Style settings. *Default = Regular.*

---

**Regular** is used when you normally have the Caps Lock key off.



KBDSTY0.

\* Regular

**Caps Lock** is used when you normally have the Caps Lock key on.



KBDSTY1.

Caps Lock

**Shift Lock** is used when you normally have the Shift Lock key on (not common to U.S. keyboards).



KBDSTY2.

Shift Lock

**Automatic Caps Lock** is used if you change the Caps Lock key on and off. The software tracks and reflects if you have Caps Lock on or off. This selection can only be used with systems that have an LED that notes the Caps Lock status (AT keyboards).



KBDSTY6.

Automatic Caps Lock

**Autocaps via NumLock** bar code should be scanned in countries (e.g., Germany, France) where the Caps Lock key cannot be used to toggle Caps Lock. The NumLock option works similarly to the regular Autocaps, but uses the NumLock key to retrieve the current state of the Caps Lock.



KBDSTY7.

Autocaps via NumLock

---

**Emulate External Keyboard** should be scanned if you do not have an external keyboard (IBM AT or equivalent).



KBDSTY5.

**Emulate External Keyboard**

*Note: After scanning the Emulate External Keyboard bar code, you must power cycle your computer.*

## **Keyboard Conversion**

Alphabetic keyboard characters can be forced to be all upper case or all lower-case. So if you have the following bar code: "abc569GK," you can make the output "ABC569GK" by scanning **Convert All Characters to Upper Case**, or to "abc569gk" by scanning **Convert All Characters to Lower Case**.

These settings override [Keyboard Style](#) selections.

*Note: If your interface is a keyboard wedge, first scan the menu code for [Automatic Caps Lock](#) (page 2-16). Otherwise, your output may not be as expected.*

*Default = Keyboard Conversion Off.*



KBDCNV0.

**\* Keyboard Conversion Off**



KBDCNV1.

**Convert All Characters  
to Upper Case**



KBDCNV2.

**Convert All Characters  
to Lower Case**

## **Control Character Output**

This selection sends a text string instead of a control character. For example, when the control character for a carriage return is expected, the output would display [CR] instead of the ASCII code of 0D. Refer to [ASCII Conversion Chart \(Code Page 1252\)](#) on page A-4. Only codes 00 through 1F are converted (the first column of the chart).

*Note: Control + ASCII Mode overrides this mode.*

---

*Default = Off.*



KBDNPE1.

**Control Character Output On**



KBDNPE0.

**\* Control Character Output Off**

## **Keyboard Modifiers**

This modifies special keyboard features, such as CTRL+ ASCII codes and Turbo Mode.

**Control + ASCII Mode On:** The scanner sends key combinations for ASCII control characters for values 00-1F. Windows is the preferred mode. All keyboard country codes are supported. DOS mode is a legacy mode, and it does not support all keyboard country codes. New users should use the Windows mode. Refer to [Keyboard Function Relationships](#), page 9-1 for CTRL+ ASCII Values.

**Windows Mode Prefix/Suffix Off:** The scanner sends key combinations for ASCII control characters for values 00-1F, but it does not transmit any prefix or suffix information.

*Default = Control + ASCII Mode Off.*



KBDCAS2.

**Windows Mode Control + ASCII Mode On**



KBDCAS0.

**\* Control + ASCII Mode Off**



KBDCAS1.

**DOS Mode Control + ASCII Mode On**



KBDCAS3.

**Windows Mode Prefix/Suffix Off**

---

**Turbo Mode:** The scanner sends characters to a terminal faster. If the terminal drops characters, do not use Turbo Mode. *Default = Off*



KBDTMD1.  
**Turbo Mode On**



KBDTMD0.  
**\* Turbo Mode Off**

**Numeric Keypad Mode:** Sends numeric characters as if entered from a numeric keypad. *Default = Off*



KBDNPS1.  
**Numeric Keypad Mode On**



KBDNPS0.  
**\* Numeric Keypad Mode Off**

**Automatic Direct Connect Mode:** This selection can be used if you have an IBM AT style terminal and the system is dropping characters. *Default = Off*



KBDADC1.  
**Automatic Direct Connect Mode  
On**



KBDADC0.  
**\* Automatic Direct Connect  
Mode Off**

---

## **RS232 Baud Rate**

Baud Rate sends the data from the scanner to the terminal at the specified rate. The host terminal must be set for the same baud rate as the scanner. *Default = 9600.*



232BAD0.

**300**



232BAD2.

**1200**



232BAD4.

**4800**



232BAD6.

**19200**



232BAD8.

**57,600**



232BAD1.

**600**



232BAD3.

**2400**



232BAD5.

**\* 9600**



232BAD7.

**38400**



232BAD9.

**115,200**



---

## ***RS232 Word Length: Data Bits, Stop Bits, and Parity***

**Data Bits** sets the word length at 7 or 8 bits of data per character. If an application requires only ASCII Hex characters 0 through 7F decimal (text, digits, and punctuation), select 7 data bits. For applications that require use of the full ASCII set, select 8 data bits per character. *Default = 8.*

**Stop Bits** sets the stop bits at 1 or 2. *Default = 1.*

**Parity** provides a means of checking character bit patterns for validity. *Default = None.*



232WRD3.

**7 Data, 1 Stop, Parity Even**



232WRD6.

**7 Data, 1 Stop, Parity Odd**



232WRD1.

**7 Data, 2 Stop Parity None**



232WRD5.

**8 Data, 1 Stop, Parity Even**



232WRD8.

**8 Data, 1 Stop, Parity Odd**



232WRD0.

**7 Data, 1 Stop, Parity None**



232WRD4.

**7 Data, 2 Stop, Parity Even**



232WRD7.

**7 Data, 2 Stop, Parity Odd**



232WRD2.

**\* 8 Data, 1 Stop, Parity None**

---

## RS232 Receiver Time-Out

The unit stays awake to receive data until the RS232 Receiver Time-Out expires. A manual or serial trigger resets the time-out. When an RS232 receiver is sleeping, a character may be sent to wake up the receiver and reset the time-out. A transaction on the CTS line will also wake up the receiver. The receiver takes 300 milliseconds to completely come up. Change the RS232 receiver time-out by scanning the bar code below, then scanning digits from the inside back cover of this manual, then scanning **Save**. The range is 0 to 300 seconds. *Default = 0 seconds (no time-out - always on).*



232LPT.

RS232 Receiver Time-Out

## RS232 Handshaking

RS232 Handshaking allows control of data transmission from the scanner using software commands from the host device. When RTS/CTS is turned **Off**, no data flow control is used.

**Flow Control, No Timeout:** The scanner asserts RTS when it has data to send, and will wait indefinitely for CTS to be asserted by the host.

**Two-Direction Flow Control:** The scanner asserts RTS when it is OK for the host to transmit. The host asserts CTS when it is OK for the device to transmit.

**Flow Control with Timeout:** The scanner asserts RTS when it has data to send and waits for a delay (see [RS232 Timeout](#) on page 2-23) for CTS to be asserted by the host. If the delay time expires and CTS is not asserted, the device transmit buffer is cleared and scanning may resume.  
*Default = RTS/CTS Off.*



232CTS1.

Flow Control, No Timeout



232CTS2.

Two-Direction Flow Control



232CTS3.

Flow Control with Timeout



232CTS0.

\* RTS/CTS Off

---

## RS232 Timeout

When using Flow Control with Timeout, you must program the length of the delay you want to wait for CTS from the host. Set the length (in milliseconds) for a timeout by scanning the bar code below, then setting the timeout (from 1-5100 milliseconds) by scanning digits from the inside back cover, then scanning **Save**.



232DEL.

RS232 Timeout

## XON/XOFF

Standard ASCII control characters can be used to tell the scanner to start sending data (**XON/XOFF On**) or to stop sending data (**XON/XOFF Off**). When the host sends the XOFF character (DC3, hex 13) to the scanner, data transmission stops. To resume transmission, the host sends the XON character (DC1, hex 11). Data transmission continues where it left off when XOFF was sent. *Default = XON/XOFF Off.*



232XON1.

XON/XOFF On



232XON0.

\* XON/XOFF Off

## ACK/NAK

After transmitting data, the scanner waits for an ACK character (hex 06) or a NAK character (hex 15) response from the host. If ACK is received, the communications cycle is completed and the scanner looks for more bar codes. If NAK is received, the last set of bar code data is retransmitted and

---

the scanner waits for ACK/NAK again. Turn on the ACK/NAK protocol by scanning the **ACK/NAK On** bar code below. To turn off the protocol, scan **ACK/NAK Off**. *Default = ACK/NAK Off.*



232ACK1.  
**ACK/NAK On**



232ACK0.  
**\* ACK/NAK Off**

## ***Scanner to Bioptic Communication***

The following settings are used to set up communication between Honeywell scanners and bioptic scanners.

*Note: The scanner's baud rate must be set to 38400 and the RS232 timeout must be set to 3000 in order to communicate with a bioptic scanner. See [RS232 Baud Rate](#) on page 2-20, and [RS232 Timeout](#) on page 2-23 for further information.*

### ***Scanner-Bioptic Packet Mode***

**Packet Mode On** must be scanned to set the scanner's format so it is compatible with a bioptic scanner. *Default = Packet Mode Off.*



232PKT0.  
**\* Packet Mode Off**



232PKT2.  
**Packet Mode On**

---

## Scanner-Bioptic ACK/NAK Mode

**Bioptic ACK/Nak On** must be scanned so the scanner will wait for an ACK or NAK from a bioptic scanner after each packet is sent. The Scanner-Bioptic ACK/NAK Timeout (below) controls how long the scanner will wait for a response. *Default = Bioptic ACK/NAK Off.*



232NAK0.

\* Bioptic ACK/NAK Off



232NAK1.

Bioptic ACK/NAK On

## Scanner-Bioptic ACK/NAK Timeout

This allows you to set the length (in milliseconds) for a timeout for a bioptic scanner's ACK/NAK response. Scan the bar code below, then set the timeout (from 1-30,000 milliseconds) by scanning digits from the inside back cover, then scanning **Save**. *Default = 5100.*



232DLK.

ACK/NAK Timeout



## Cordless System Operation

*Note: This chapter applies only to cordless scanning systems. It does not apply to corded scanners.*

### How the Cordless Charge Base/Access Point Works

A cordless charge base or an Access Point provide the link between the cordless scanner and the host system. The base/Access Point contains an interface assembly and an RF communication module. The RF communication module performs the data exchange between the cordless scanner and the interface assembly. The control assembly coordinates the central interface activities including: transmitting/receiving commands and data to/from the host system, performing software activities (parameter menuing, visual indicator support, power-on diagnostics), and data translation required for the host system.

The cordless charge base is also a scanner's battery charger. Refer to [Charging Information](#), page 3-5, for additional information.

### Linking the Scanner to a Charge Base

Turn off power before connecting a base, then power up the computer once the base is fully connected. When the base is connected and powered up, put the scanner in the base to establish a link. The green LED on the base flashes to indicate the scanner's battery is charging.

If the scanner and base have previously been linked, you do not receive any feedback. If this is the first time that the scanner and base are linked, both devices emit a short chirp when their radios link. At this point, that one scanner is linked to one base.

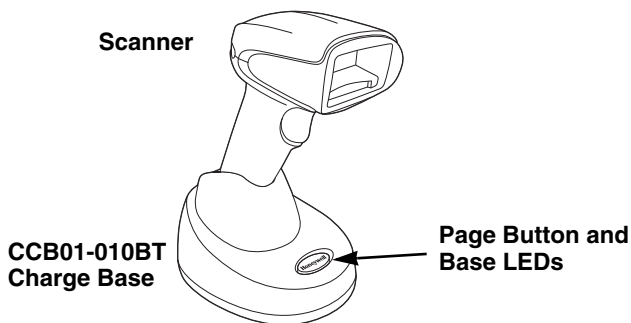

To determine if your cordless system is set up correctly, scan one of the sample bar codes in the back of this manual. If the scanner provides a single good read beep and the green LED lights, the scanner has successfully linked to the base. If you receive an error tone and the red LED lights, the scanner has not linked to the base. Refer to [page 13-6](#) for troubleshooting information.

---

## ***Linking the Scanner to an Access Point***

Turn on the computer (laptop/desktop). Plug the interface cable into the Access Point first and then into the appropriate port on the computer. The Page button lights up when the connection to the host is made.

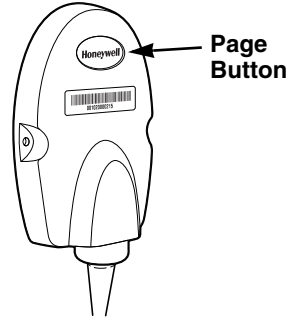

Scan the linking bar code on the top of the Access Point to establish a connection between the Access Point and the scanner. The scanner emits a short beep and flashes the green LED to confirm a connection with the Access Point. The Access Point's Page button remains blue.

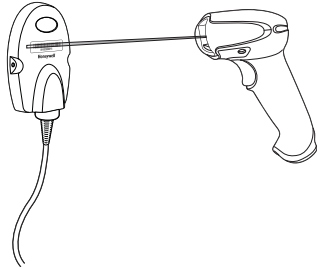

## ***Communication Between the Cordless System and the Host***

The cordless scanner provides immediate feedback in the form of a "good read" indication (a green LED on the scanner and an audible beep) after a bar code is scanned correctly and the base or Access Point has acknowledged receiving the data. This is possible since the cordless system provides two-way communication between the scanner and the base or Access Point.

When data is scanned, the data is sent to the host system via the base or Access Point. The cordless scanner recognizes data acknowledgement (ACK) from the base or Access Point. If it cannot be determined that the data has



---

been properly sent to the base or Access Point, the scanner issues an error indication. You must then check to see if the scanned data was received by the host system.

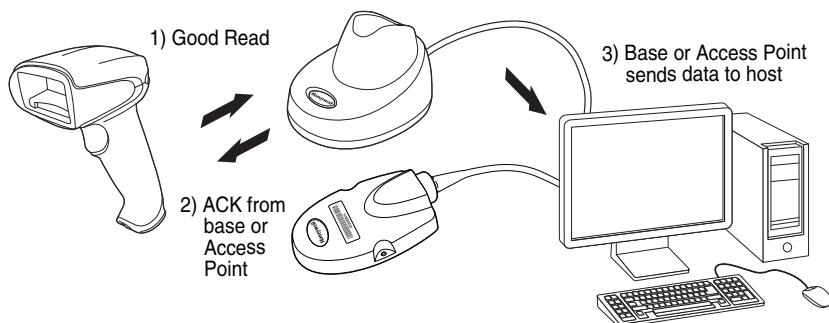

## ***RF (Radio Frequency) Module Operation***

The cordless system uses a two-way Bluetooth® radio to transmit and receive data between the scanner and the base or Access Point. Designed for point-to-point and multipoint-to-single point applications, the radio operates using a license free ISM band, which sends relatively small data packets at a fast data rate over a radio signal with randomly changing frequencies, makes the cordless system highly responsive to a wide variety of data collection applications and resistant to noisy RF environments. Bluetooth Class 2 power level provides a communication range of 33 feet (10m) between the scanner and base or Access Point, depending on the environment. See [Flexible Power Management](#), page 3-17, for information about controlling this range.

## ***System Conditions***

The components of the cordless system interact in specific ways as you associate a scanner to a base or Access Point, as you move a scanner out of range, bring a scanner back in range, or swap scanners between two cordless systems. The following information explains the cordless system operating conditions.

### ***Linking Process***

Once a scanner is placed into a cordless charge base, the scanner's battery charge status is checked, and software automatically detects the scanner and links it to the base depending on the selected link mode.

Refer to [Linking the Scanner to an Access Point](#), page 3-2, for information about linking to an Access Point.

---

## ***Scanner Is Out of Range***

The cordless scanner is in communication with its base or Access Point, even when it is not transmitting bar code data. Whenever the scanner can't communicate with the base or Access Point for a few seconds, it is out of range. If the scanner is out of range and you scan a bar code, the scanner issues an error tone indicating no communication with the base or Access Point. A cordless charge base can also sound an alarm. Refer to [Out-of-Range Alarm](#), page 3-14.

## ***Scanner Is Moved Back Into Range***

The scanner relinks if the scanner or the base or Access Point have been reset, or the scanner comes back into range. If the scanner relinks, you will hear a single chirp when the relinking process (uploading of the parameter table) is complete. Refer to [Out-of-Range Alarm](#) on page 3-14 for further information.

## ***Out of Range and Back into Range with Batch Mode On***

The scanner may store a number of symbols (approximately 500 U.P.C. symbols; others may vary) when it is out of range and then send them to the base or Access Point when back in range (see [Batch Mode](#) on page 3-18).

You will not hear a communication error tone in this mode, but you will hear a short buzz when you pull the trigger if the radio communication is not working. Once the radio connection is made, the scanner produces a series of beeps while the data is being transferred to the base or Access Point.

## ***Page Button***

When you press the Page button on the base or Access Point, the scanners associated with that base or Access Point will begin beeping (3 short and 1 long beep). If you pull the trigger on a scanner that is beeping in response, or press the Page button on the base or Access Point a second time, all associated scanners will stop beeping. See [Paging](#) on page 3-9 for further information about Page Button settings.

## ***About the Battery***



There is a danger of explosion if the batteries are incorrectly replaced. Replace the batteries with only the same or equivalent type recommended by the manufacturer. Dispose of used batteries according to the recycle program for batteries as directed by the governing agency for the country where the batteries are to be discarded.

Power is supplied to the cordless scanner by a rechargeable battery that is integrated in the scanner handle. Batteries are shipped approximately 30% to 60% charged. The battery should be charged for a minimum of 4 hours before initial use to ensure optimal performance.

---

## Charging Information

The battery is designed to charge while the scanner is positioned in the cordless base unit. Refer to [Base/Access Point LED Sequences and Meaning](#), page 3-7, for an interpretation of the Charge Status indicators. Refer to [Charge Only Mode](#) (page 3-12) if you need to charge a scanner without linking it to the base.

Place the scanner in the base that is connected to an appropriate power supply. Use only a Listed Limited Power Source (LPS) or Class 2 type power supply with output rated 5 to 5.2Vdc, 1A.

*Note: If you are powering the base through the interface cable (for example, a USB cable) and not using an external power supply plugged into the aux port, the current available for charging is reduced and charge times are increased.*

## Battery Recommendations

- The battery is a lithium ion cell and can be used without a full charge, and can also be charged without fully discharging, without impacting the battery life. There is no need to perform any charge/discharge conditioning on this type of battery.
- Keep the base connected to power when the host is not in use.
- Replace a defective battery immediately since it could damage the scanner.
- Although your battery can be recharged many times, it will eventually be depleted. Replace it after the battery is unable to hold an adequate charge.
- If you are not sure if the battery or charger is working properly, send it to Honeywell International Inc. or an authorized service center for inspection. Refer to [Customer Support](#) on page 14-1 for additional information.



### Caution:

Use only Honeywell Li-ion battery packs, part number 100000495, rated 3.7 Vdc, 7.4Whr, or part number L01J43002, rated 3.6Vdc, 8.0Whr in this device. Use of any non-Honeywell battery may result in damage not covered by the warranty.

## Safety Precautions for Lithium Batteries

- Do not place batteries in fire or heat the batteries.
- Do not store batteries near fire or other high temperature locations.
- Do not store or carry batteries together with metal objects.
- Do not expose batteries to water or allow the batteries to get wet.
- Do not connect (short) the positive and negative terminals, of the batteries, to each other with any metal object.
- Do not pierce, strike or step on batteries or subject batteries to strong impacts or shocks.
- Do not disassemble or modify batteries.

**Caution:**

Danger of explosion if batteries are incorrectly replaced. Dispose of used batteries according to the recycle program for batteries as directed by the governing agency for the country where the batteries are to be discarded.

***Proper Disposal of the Battery***

When the battery has reached the end of its useful life, the battery should be disposed of by a qualified recycler or hazardous materials handler. Do not incinerate the battery or dispose of the battery with general waste materials. You may send the scanner's battery to us. (postage paid). The shipper is responsible for complying with all federal, state, and local laws and regulations related to the packing, labeling, manifesting, and shipping of spent batteries. Contact the Product Service Department ([page 14-1](#)) for recycling or disposal information. Since you may find that your cost of returning the batteries significant, it may be more cost effective to locate a local recycle/disposal company.

***Beeper and LED Sequences and Meaning***

The scanner contains LEDs on the rear of the unit that indicate linking status, decoding state, and battery condition. The base has LEDs on the top of the unit that indicate its power up, communication, and battery charge condition. The red LED = error; green LED = success of any type. The unit's audible indicators have meaning as well: 1 razz or error tone = error; 2 beeps = menu change; 1 beep = all other successes.

The table below lists the indication and cause of the LED illumination and beeps for the scanner.

## Scanner LED Sequences and Meaning

LED Indication	Beeper Indication	Cause
<b>Normal Operation</b>		
Red Flash	None	Battery low
Green Flash	1 beep	Successful communication or linking
Red, blinking	Razz or error tone	Failed communication
<b>Menu Operation</b>		
Green Flash	2 beeps	Successful menu change
Red, blinking	Razz or error tone	Unsuccessful menu change

## Base/Access Point LED Sequences and Meaning

The base contains a red LED and the Access Point has a blue LED that indicate the status of the unit and verifies its communication with the host system. The base also has a green LED that indicates scanner battery charge condition.

<b>Red or Blue LED - Host Communication</b>	
Red or Blue LED	Communication Condition
Off	USB suspend
On continuously	Power on, system idle
Short blinks in multiple pulses. Occurs while transferring data to/from the RF module or the Host port.	Receiving data
<b>Green LED - Scanner Battery</b> (base only, does not apply to Access Point)	
Green LED	Charge Condition
Off	Battery not detected or charge suspended
Slow flash, 1 second on, 1 second off	Pre-charge and charging
On continuously	Charge complete
Fast flash, 300 mSec on, 300 mSec off	Charge Error

---

## **Base Power Communication Indicator**

To display the power indicator on a base or an Access Point, scan the **Base Power Communication Indicator On** bar code. To turn off the power indicator, scan the **Off** bar code. *Default = On.*



:\*BASRED1.

**\* Base Power Communication  
Indicator On**



:\*BASREDO.

**Base Power Communication  
Indicator Off**

## **Reset Scanner**

Scanning this bar code reboots the scanner and causes it to relink with the base or Access Point.



RESET\_.

**Reset Scanner**

## **Scanning While in Base Cradle**

*Note: This feature does not apply to the Access Point.*

---

If you want to be able to scan bar codes while the scanner is in the base cradle, scan the **Scanning in Cradle On** bar code below. If you want to only allow scanning when the scanner is out of the base cradle, scan **Scanning in Cradle Off**. If you want the scanner to shut down when in the base cradle, scan **Shut Down Scanner in Cradle**. *Default = Scanning in Cradle On.*



BT\_SIC0.

Scanning in Cradle Off



BT\_SIC1.

\* Scanning in Cradle On



BT\_SIC2.

Shut Down Scanner in Cradle

## Paging

### Paging Mode

By default, the paging button on the base or Access Point pages the scanners associated with that base or Access Point. If you want the paging button on your base or Access Point to be disabled, scan the **Paging Mode Off** bar code, below. When Paging Mode is off, the base or Access Point will no longer page scanners when the button is pressed. The red LED on the base or blue LED on the Access Point will remain lit to indicate that Paging Mode is off. (This light will go out when the button is pressed, then back on when it's released.) *Default = Paging Mode On.*



BEPPGE1.

\* Paging Mode On



BEPPGE0.

Paging Mode Off

---

## Paging Pitch

When you press the Page button on the base or Access Point, the scanners associated with that base or Access Point will begin beeping (see [Page Button](#) on page 3-4). You can set the pitch of the paging beep for each scanner by scanning one of the following bar codes. *Default = Low.*



BEPPFQ1000.  
\* Low (1000 Hz)



BEPPFQ3250.  
Medium (3250 Hz)



BEPPFQ4200.  
High (4200 Hz)

## Error Indicators

### Beeper Pitch - Base Error

*Note: This feature does not apply to the Access Point.*

The base can be configured to beep at a particular pitch when an error occurs, such as transmission problems to a host system. The beeper pitch codes modify the pitch (frequency) of the error tone the base emits when there is an error. *Default = Low.*



BASFQ2250.  
\* Razz (250 Hz)



BASFQ23250.  
Medium (3250 Hz)



BASFQ24200.  
High (4200 Hz)

### Number of Beeps - Base Error

*Note: This feature does not apply to the Access Point.*



---

The number of beeps and LED flashes emitted by the base for an error condition can be programmed from 1 - 9. For example, if you program this option to have five error beeps, there will be five error beeps and five LED flashes in response to an error. To change the number of error beeps, scan the bar code below and then scan a digit (1-9) bar code and the **Save** bar code on the [Programming Chart](#) inside the back cover of this manual.  
*Default = 1.*



BASERR.

**Number of Base Error Beeps/LED Flashes**

## ***Scanner Report***

Scan the bar code below to generate a report for the connected scanners. The report indicates the port, work group, scanner name, and address. To assign a name to your scanner, refer to [Menu Command Syntax](#), page 11-1.



RPTSCN.

**Scanner Report**

## ***Scanner Address***

Scan the bar code below to determine the address of the scanner you are using.



BT\_LDA.

**Scanner Address**

## ***Base or Access Point Address***

Scan the bar code below to determine the address of the base or Access Point you are using.



.\*:BASLDA.

**Base Address**

---

## Scanner Modes

The Xenon is capable of working in single scanner mode, multiple scanner mode, or with Bluetooth devices other than the CCB01-010BT charge base or Access Point.

### Charge Only Mode

There may be times when you want to charge your scanner, but not link to the base. For example, if a scanner is linked to an Access Point or other Bluetooth device and you need to charge the scanner, but want to retain your existing link.

In order to program the base for Charge Only Mode, you must link a scanner to it. Once the scanner is linked to the base, scan the **Charge Only Mode** bar code. Any subsequent scanners placed in that base will charge without linking to it. The scanner used to program the base remains linked to the base. To unlink this scanner, scan [Unlink Scanner](#) on page 3-13.



:\*:BASLNK0.  
**Charge Only Mode**

*Note: When in Charge Only Mode, the scanner periodically wakes up and beeps. See "Power Up Beeper" on page 4-1 to change this setting.*

If you want to charge a scanner and link to the base, use **Charge and Link Mode**. If the base is programmed for Charge Only Mode, you must link a scanner to it first in order to program it for Charge and Link Mode. Scan the linking bar code on the base to link the scanner, then scan **Charge and Link Mode**. *Default = Charge and Link Mode.*



:\*:BASLNK1.  
**\* Charge and Link Mode**

### Linked Modes

Locked Link Mode and Open Link Mode are the link modes that accommodate different applications. Scan the appropriate bar codes included in the Open Link and Locked Link Mode explanations that follow to switch from one mode to another. *Default = Open Link Mode.*

---

## ***Locked Link Mode - Single Scanner***

If you link a scanner to a base or an Access Point using the Locked Link Mode, other scanners are blocked from being linked if they are inadvertently placed into the base, or if the Access Point linking bar code is scanned. If you do place a different scanner into a base, it will charge the scanner, but the scanner will not be linked.



BASCON0,DNG1.

**Locked Link Mode  
(Single Scanner)**

To use a different scanner, you need to unlink the original scanner by scanning the **Unlink Scanner** bar code. (See [Scanner Modes](#), page 3-12.)

## ***Open Link Mode - Single Scanner***

When newly shipped or defaulted to factory settings, a scanner is not linked to a base or an Access Point. A link is established when the scanner is placed into a base, or an Access Point linking bar code is scanned. When in Open Link Mode, a new link is established when a new scanner is placed in the base, or you scan an Access Point linking bar code. Each time a scanner is placed into a base or scans an Access Point linking bar code, the scanner becomes the linked to the base or Access point and the old scanner is unlinked.



BASCON1,DNG1.

**\* Open Link Mode  
(Single Scanner)**

## ***Unlinking the Scanner***

If a base or an Access Point has a scanner linked to it, that scanner must be unlinked before a new scanner can be linked. Once the previous scanner is unlinked, it will no longer communicate with the base or Access Point. To unlink the scanner from a base or an Access Point, scan the **Unlink Scanner** bar code below.



BT\_RMV.

**Unlink Scanner**

---

## Override Locked Scanner

If you need to replace a broken or lost scanner that is linked to a base or an Access Point, scan the **Override Locked Scanner** bar code below with a new scanner and place that scanner in the base, or scan the Access Point linking bar code. The locked link will be overridden; the broken or lost scanner's link with the base or Access Point will be removed, and the new scanner will be linked.



BT\_RPL1.

**Override Locked Scanner  
(Single Scanner)**

## Out-of-Range Alarm

If your scanner is out range of the base, an alarm sounds from both your base and scanner. If your scanner is out range of an Access Point, an alarm sounds from just the scanner. The alarm stops when the scanner is moved closer to the base or Access Point, when the base or Access Point connects to another scanner, or when the alarm duration expires. To activate the alarm options for the scanner or the base and to set the alarm duration, scan the appropriate bar code below and then set the time-out duration (from 0-3000 seconds) by scanning digits on the [Programming Chart](#) inside the back cover, then scanning **Save**. *Default = 0 sec (no alarm).*



BASORD.

**Base Alarm Duration**

*Note: The Access Point does not have a base alarm.*



BT\_ORD.

**Scanner Alarm Duration**

*Note: If you are out of range when you scan a bar code, you will receive an error tone even if you do not have the alarm set. You receive the error tone since the data could not be communicated to the base or Access Point or the host.*

## Alarm Sound Type

You may change the alarm type for the scanner or base by scanning the appropriate bar code below and then scanning a digit (0-7) bar code and the **Save** bar code on the [Programming Chart](#) inside the back cover of this manual. *Default = 0.*

---

The sounds are as follows:

Setting	Sound
0	3 long beeps, medium pitch
1	3 long beeps, high pitch
2	4 short beeps, medium pitch
3	4 short beeps, high pitch
4	single chirps, medium pitch
5	2 chirps, then 1 chirp, medium pitch
6	single chirps, high pitch
7	2 chirps, then 1 chirp, high pitch



BASORW.  
**Base Alarm Type**

*Note: The Access Point does not have a base alarm.*



BT\_ORW.  
**Scanner Alarm Type**

## ***Scanner Power Time-Out Timer***

*Note: Scanner Power Time-out Timer only applies to cordless systems. It does not apply to corded scanners.*

When there is no activity within a specified time period, the scanner enters low power mode. Scan the appropriate scanner power time-out bar code to change the time-out duration (in seconds).

*Note: Scanning zero (0) is the equivalent of setting no time-out.*

---

If there are no trigger pulls during the timer interval, the scanner goes into power down mode. Whenever the trigger is enabled, the timer is reset. If the scanner is placed in the charge base cradle and the battery is in the process of being charged, the scanner will not go into power down mode. *Default = 3600 seconds.*



**BT\_LPT0.  
0 seconds**



**BT\_LPT200.  
200 seconds**



**BT\_LPT400.  
400 seconds**



**BT\_LPT900.  
900 seconds**



**BT\_LPT3600.  
\* 3600 seconds**



**BT\_LPT7200.  
7200 seconds**

*Note: When the scanner is in power down mode, pull the trigger to power the unit back up. There will be a set of power up beeps and a delay of up to a few seconds for the radio to join. The scanner will then be ready to use.*

---

## Flexible Power Management

If you are experiencing network performance issues, and suspect the scanner is interfering with other devices, you can turn down the power output of the scanner. This reduces the range between the scanner and a base or an Access Point as shown in the following illustration:

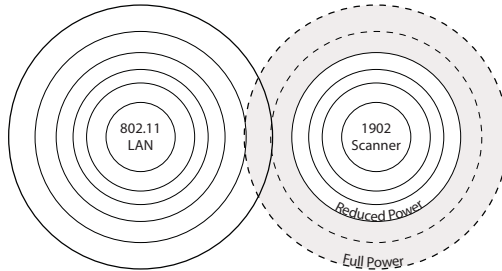

Scan one of the bar codes below to set the scanner's power output to **Full Power** (100%) [2.5mW, 4dBm], **Medium Power** (35%) [.875mW, 0dBm], **Medium Low Power** (5%) [.125mW, -9dBm], or **Low Power** (1%, .025mW, -16dBm). *Default = Full Power.*

For the new power setting to take effect, the scanner and the base or Access Point must be reset. See [Reset Scanner and Base/Access Point](#) (page 3-18).



BT\_TXP100.  
\* Full Power



BT\_TXP35.  
Medium Power



BT\_TXP5.  
Medium Low Power



BT\_TXP1.  
Low Power

---

## Reset Scanner and Base/Access Point

Once the power level is set, you must scan the **Reset Base** bar code and wait for the scanner to unlink and relink to a base or an Access Point. Once that is done, scan the **Reset Scanner** bar code and wait for the base or Access Point to unlink and relink to the scanner.



RESET\_  
Reset Base



: \* : RESET\_ . 3  
Reset Scanner

## Batch Mode

Batch mode is used to store bar code data when a scanner is out of range of its base or Access Point, or when performing inventory. The data is transmitted to the base or Access Point once the scanner is back in range or when the records are manually transmitted.

*Note: Batch mode has limitations when using multiple scanners to one base or Access Point. If a cordless system is being used in "multiple link mode," where up to 7 scanners are to be connected to one base or Access Point, some accumulated or batched scans could be lost if scanners are constantly being moved in and out of range.*

**Automatic Batch Mode** stores bar code data when the scanner is out of range of the base or Access Point. The data is automatically transmitted to the base or Access Point once the scanner is back in range. When the scanner's buffer space is full, any bar codes scanned generate an error tone. In order to scan bar codes again, the scanner must be moved back into range of the base or Access Point so data can be transmitted.

**Inventory Batch Mode** stores bar code data, whether or not you are in range of the base or Access Point. To transmit the stored data to the base or Access Point, either place the scanner in the base, or scan [Transmit Inventory Records](#) (page 3-24). When the scanner's buffer space is full, any bar codes scanned generate an error tone. In order to scan bar codes again, the data must be transmitted to the base or Access Point.



---

*Default = Batch Mode Off.*



BATENA0.

\* **Batch Mode Off**



BATENA1.

**Automatic Batch Mode**



BATENA2.

**Inventory Batch Mode**

### ***Batch Mode Beep***

When scanning in [Inventory Batch Mode](#) (page 3-19), the scanner beeps every time a bar code is scanned. When **Batch Mode Beep** is **On**, you will also hear a click when each bar code is sent to the host. If you do not want to hear these clicks, scan **Batch Mode Beep Off**. *Default = Batch Mode Beep On.*



BATBEP0.

**Batch Mode Beep Off**



BATBEP1.

\* **Batch Mode Beep On**

### ***Batch Mode Storage***

When a scanner is storing data during a Batch Mode process, you can select whether the data is stored in Flash memory or in RAM.

**Flash Storage:** The scanner writes any untransmitted data to flash memory prior to powering down. The data will still be there when the scanner powers back up. However, the scanner will power down, even with untransmitted data, if it reaches a power down timeout or if the battery power is very low.

---

**RAM Storage:** The scanner will not power down while it contains data that has not been transmitted to the base or Access Point, even if it reaches a power down timeout. However, if the scanner runs out of battery power, it will power down and the data will be lost.

*Default = Flash Storage.*



BATNVS1.

\* **Flash Storage**



BATNVS0.

**RAM Storage**

## **Batch Mode Quantity**

When in Batch Mode, you may wish to transmit the number of multiple bar codes scanned, rather than a single bar code multiple times. For example, if you scan three bar codes called XYZ with **Batch Mode Quantity Off**, when you transmit your data it will appear as XYZ three times. Using **Batch Mode Quantity On** and the **Quantity Codes** (page 3-22), you could output your data as “XYZ, 00003” instead.

*Note: If you wish to format your output, for example, place a CR or tab between the bar code data and the quantity, refer to [Data Formatting](#) beginning on page 6-1.*

*Default = Batch Mode Quantity Off.*



BATQTY0.

\* **Batch Mode Quantity Off**



BATQTY1.

**Batch Mode Quantity On**

## **Entering Quantities**

Quantity Codes (page 3-22) allow you to enter a quantity for the last item scanned, up to 9999 (default = 1). Quantity digits are shifted from right to left, so if a 5th digit is scanned, the 1st digit scanned is discarded and the 2nd, 3rd and 4th digits are moved to the left to accommodate the new digit.

For example, if the Quantity 5 bar code is scanned after the quantity has been set to 1234, then the 1 is dropped, the quantity will be 2345.

---

**Example:** Add a quantity of 5 for the last item scanned.

1. Scan the item's bar code.
2. Scan the quantity 5 bar code.

**Example:** Add a quantity of 1,500 for the last item scanned.

1. Scan the item's bar code.
2. Scan the quantity 1 bar code.
3. Scan the quantity 5 bar code.
4. Scan the quantity 0 bar code.
5. Scan the quantity 0 bar code.

**Example:** Change a quantity of 103 to 10.

To correct an incorrect quantity, scan the quantity 0 bar code to replace the incorrect digits, then scan the correct quantity bar codes.

1. Scan the quantity 0 bar code to change the quantity to 1030.
2. Scan the quantity 0 bar code to change the quantity to 0300.
3. Scan the quantity 1 bar code to change the quantity to 3001.
4. Scan the quantity 0 bar code to change the quantity to 0010.

*Default = 1.*

---

## **Quantity Codes**



BATNUM0.

0



BATNUM2.

2



BATNUM4.

4



BATNUM6.

6



BATNUM8.

8



BATNUM1.

1



BATNUM3.

3



BATNUM5.

5



BATNUM7.

7



BATNUM9.

9

---

## ***Batch Mode Output Order***

When batch data is transmitted, select whether you want that data sent as **FIFO** (first-in first-out), or **LIFO** (last-in first-out). *Default = Batch Mode FIFO.*



BATLIFO.

\* **Batch Mode FIFO**



BATLIF1.

**Batch Mode LIFO**

## ***Total Records***

If you wish to output the total number of bar codes scanned when in Batch Mode, scan **Total Records**.



BATNRC.

**Total Records**

## ***Delete Last Code***

If you want to delete the last bar code scanned when in Batch Mode, scan **Delete Last Code**.



BATUND.

**Delete Last Code**

## ***Clear All Codes***

If you want to clear the scanner's buffer of all data accumulated in Batch Mode, scan **Clear All Codes**.



BATCLR.

**Clear All Codes**

---

## Transmit Records to Host

If you are operating in Inventory Batch Mode (see [Inventory Batch Mode](#) on page 3-19), you must scan the following bar code to transmit all the stored data to the host system.



BAT\_TX.

Transmit Inventory Records

## Batch Mode Transmit Delay

Sometimes when accumulated scans are sent to the host system, the transmission of those scans is too fast for the application to process. To program a transmit delay between accumulated scans, scan one of the following delays. *Default = Off.*

*Note: In most cases, a short (250 ms (milliseconds)) delay is ideal, however, longer delays may be programmed. Contact Technical Support ([page 14-2](#)) for additional information.*



BATDLY0.

\* Batch Mode Transmit Delay Off  
(No Delay)



BATDLY250.

Batch Mode Transmit Delay Short  
(250 ms)



BATDLY500.

Batch Mode Transmit Delay Medium  
(500 ms)



BATDLY1000.

Batch Mode Transmit Delay Long  
(1000 ms)

## Multiple Scanner Operation

*Note: Multiple Scanner Operation Mode allows you to link up to 7 scanners to one base or Access Point. You cannot join an 8th scanner until you unlink one of the 7 scanners or take a scanner out of range.*

---

To put the scanner in multiple scanner mode, scan the bar code below. Once you scan this bar code, the scanner is unlinked from the base or Access Point and must either be placed into the base, or you must scan the Access Point linking bar code in order to relink.



BASCON2,DNG3.

**Multiple Scanner Operation**

## ***Scanner Name***

You may assign a name to each scanner you are using for identification purposes. For example, you may want to have a unique identifier for a scanner that is receiving imaging commands sent from the base or Access Point.

The default name for a Xenon is “Xenon.” If you have more than one scanner linked to a base, and they all have the same default name, the first scanner linked to the base receives commands. When renaming a series of scanners with identical default names, unlink all except one of the scanners from the base.

Perform the rename operation using either the bar codes on [page 3-26](#), or by sending the serial command **:Xenon:BT\_NAMname**. where *name* is the new name for the scanner. If you wish to change the names of additional scanners, link them one at a time and repeat the **:Xenon:BT\_NAMname**. command for each scanner.

---

To rename scanners with sequential, numeric names, scan the bar codes below. Scan the **Reset** code after each name change and wait for the scanner to relink to the base or Access Point before scanning a bar code to rename the next scanner.



BT\_NAM0001.  
0001



BT\_NAM0002.  
0002



BT\_NAM0003.  
0003



BT\_NAM0004.  
0004



BT\_NAM0005.  
0005



BT\_NAM0006.  
0006



BT\_NAM0007.  
0007



RESET\_  
Reset

You may also scan the **Scanner Name** bar code below and scan a number for the scanner name. For example, if you wanted to name the linked scanner “312,” you would scan the bar code below, scan the **3**, **1**, and **2** bar codes on the [Programming Chart](#) inside the back cover of this manual, then scan **Save**. Scan the **Reset** bar code and wait for the scanner to relink to the base.



BT\_NAM.  
Scanner Name



---

## ***Application Work Groups***

Your cordless system can have up to 7 scanners linked to one base or Access Point. You can also have up to 7 work groups. If you want to have all of the scanners' settings programmed alike, you don't need to use more than 1 work group. If you want each scanner to have unique settings (e.g., beeper volume, prefix/suffix, data formatter), then you may program each scanner to its own unique work group and may program each scanner independently. For example, you might want to have multiple work groups in a retail/warehouse application where you need to have different data appended to bar codes used in the warehouse area versus the retail area. You could assign all the scanners in the retail area to one work group and those in the warehouse to another. Consequently, any desired changes to either the retail or warehouse area would apply to all scanners in that particular work group. Honeywell's online configuration tool, EZConfig-Scanning ([page 10-2](#)), makes it easy for you to program your system for use with multiple scanners and multiple work groups.

The scanner keeps a copy of the menu settings it is using. Whenever the scanner is connected or reconnected to a base or an Access Point, the scanner is updated with the latest settings from the base or Access Point for its work group. The scanner also receives menu setting changes processed by the base or Access Point. If a scanner is removed from a base or an Access Point and placed into another base or linked to another Access Point, it will be updated with the new base/Access Point settings for whatever work group to which that the scanner was previously assigned. For example, if the scanner was in work group 1 linked to the first base, it will be placed in work group 1 in the second base with the associated settings.

---

## ***Application Work Group Selection***

This programming selection allows you to assign a scanner to a work group by scanning the bar code below. You may then program the settings (e.g., beeper volume, prefix/suffix, data formatter) that your application requires. *Default = Group 0.*



GRPSEL0.  
**\* Group 0**



GRPSEL1.  
**Group 1**



GRPSEL2.  
**Group 2**



GRPSEL3.  
**Group 3**



GRPSEL4.  
**Group 4**



GRPSEL5.  
**Group 5**



GRPSEL6.  
**Group 6**

## ***Resetting the Factory Defaults: All Application Work Groups***

The following bar code defaults all of the work groups to the factory default settings.



PAPDFT&  
**Factory Default Settings:  
All Work Groups**

---

To see what the factory default settings are, refer to the table of [Menu Commands](#), beginning on page 11-5. The standard product default settings for each of the commands are indicated by an asterisk (\*).

*Note: Scanning this bar code also causes both the scanner and the base or Access Point to perform a reset and become unlinked. The scanner must be placed in the base, or the Access Point linking bar code must be scanned to re-establish the link. Refer to [Scanner Modes](#), page 3-12 for additional information.*

*If your scanner is in multiple scanner mode, you will hear up to 30 seconds of beeping while all scanners are relinked to the base or Access Point and the settings are changed.*

## **Resetting the Custom Defaults: All Application Work Groups**

If you want the custom default settings restored to all of the work groups, scan the **Custom Product Default Settings** bar code below. (If there are no custom defaults, it will reset the work groups to the factory defaults.) See [Setting Custom Defaults](#) on page 1-10 for further information about custom defaults.



PAPDFT.

**Custom Default Settings:  
All Work Groups**

*Note: Scanning this bar code also causes both the scanner and the base or Access Point to perform a reset and become unlinked. The scanner must be placed in its base, or the Access Point linking bar code must be scanned to re-establish the link. Refer to [Scanner Modes](#), page 3-12 for additional information.*

*If your scanner is in multiple scanner mode, you will hear up to 30 seconds of beeping while all scanners are relinked to the base or Access Point and the settings are changed.*

## **Using the Scanner with Bluetooth Devices**

The scanner can be used either with the CCB01-010BT charge base, an Access Point, or with other Bluetooth devices. Those devices include personal computers, laptops, PDAs, and Honeywell mobility systems devices.

### **Bluetooth HID Keyboard Connect**

Your scanner can be paired with Bluetooth-capable devices, such as iPads, smart phones, and laptops, so that scanned data appears on your device screen as though it was entered on the keyboard. In order to pair with the Bluetooth device:

- 
1. Scan the **Bluetooth HID Keyboard Connect** bar code below.



PAPBTH.

**Bluetooth HID Keyboard  
Connect**

2. Set the Bluetooth-capable host device so it searches for other Bluetooth devices. (Refer to your device's User's Guide for pairing instructions.)
3. Once your host device has located the scanner, select the scanner name. The host generates and displays a random PIN that must be scanned within 60 seconds. You must quickly scan **Bluetooth PIN Code**, then the numbers from the following page, then **Save**.



BT\_PIN.

**Bluetooth PIN Code**



K0K

0



K2K

2



K4K

4



K6K

6



K8K

8



MNUSAV.

**Save**



K1K

1



K3K

3



K5K

5



K7K

7



K9K

9

---

## **Bluetooth HID Keyboard Disconnect**

If your scanner has been connected directly to an iPad, smart phone, or laptop using [Bluetooth HID Keyboard Connect](#) (page 3-29), you must disconnect it in order to once again communicate with the base or Access Point. Scan the **Bluetooth HID Keyboard Disconnect** bar code to unlink the scanner from the currently linked host. Scan the linking bar code on the base or Access Point to relink the scanner.



PAPSPP.

**Bluetooth HID Keyboard Disconnect**

## **Bluetooth Serial Port - PCs/Laptops**

Scanning the **Non-Base BT Connection** bar code below allows the scanner to be used with other Bluetooth devices (e.g., PC/laptop). When in this mode, the scanner behaves like an RS-232 serial device, and you will need to open a COM port on the host to read scanned data.

After you scan the bar code below, follow the instructions supplied with your Bluetooth device to locate the scanner and connect to it. If you go out of range with your scanner, the scanner will not reconnect to the Bluetooth device when it is back in range. If you want to relink to the charge base or Access Point, refer to [Override Locked Scanner](#), page 3-14.

*Note: The multiple work groups option is not available when you are using the scanner with Bluetooth devices other than the charge base or Access Point.*



BT\_TRM0;BT\_DNG5.

**Non-Base BT Connection**

## **PDAs/Mobility Systems Devices**

You may also use the scanner with a PDA or a Honeywell Mobility Systems device. Scan the bar code below and follow the instructions supplied with your Bluetooth device to locate the scanner, and connect with it.



BT\_TRM0;BT\_DNG1.

**BT Connection - PDA/Mobility Systems Device**

---

## Changing the Scanner's Bluetooth PIN Code

Some devices require a PIN code as part of the Bluetooth security features. Your scanner's default PIN is 1234, which you may need to enter the first time you connect to your PDA or PC. The PIN code must be between 1 and 16 characters. To change the PIN, scan the bar code below and then scan the appropriate numeric bar codes from the [Programming Chart](#) inside the back cover of this manual. Scan **Save** to save your selection.



BT\_PIN.  
Bluetooth PIN

## Minimizing Bluetooth/ISM Band Network Activity

The settings described below can help you customize the relinking behavior of the cordless area-imaging system to obtain the best compromise between convenience and low interference.

*Note: ISM band refers to the 2.4 to 2.48 GHz frequency band used by wireless networks, cordless phones, and Bluetooth.*

### Auto Reconnect Mode

Auto Reconnect controls whether or not the scanner automatically begins the relink process when a loss of connection is detected. When the **Auto Reconnect On** bar code is scanned, the scanner begins the relink process immediately, without user intervention. *Default = Auto Reconnect On.*



BT\_ACM1.  
\* Auto Reconnect On



BT\_ACM0.  
Auto Reconnect Off

*Note: If you are connecting to a Bluetooth Interface Module, set Auto Reconnect to Off.*

The table below shows the results of the Auto Reconnect On and Off settings:

Event	Auto Reconnect On	Auto Reconnect Off
Scanner out of range	Relink occurs automatically. If maximum number of link attempts is unsuccessful, then the scanner must be relinked by either pulling the trigger, placing the scanner in the base, or scanning the Access Point linking bar code. (See <a href="#">Maximum Link Attempts</a> on page 3-34.)	The scanner is relinked by pulling the trigger, or scanning the Access Point linking bar code.
Base or Access point reset (firmware upgrade or power cycle)	Scanner behaves as if out of range.	No attempt to relink made while base or Access Point is powered off. Trigger must be pulled to initiate relinking.
Scanner power down due to Power Time-Out Timer setting (see <a href="#">page 4-8</a> )	Trigger must be pulled, Access Point linking bar code must be scanned, or the scanner must be placed in the base unit to relink. (Note: scanner relinks on power up, but powers on due to one of the above actions.)	
Scanner reset due to firmware upgrade	Relink occurs automatically.	
Scanner reset due to battery change	Relink occurs automatically.	
Scanner placed in different base unit	Relink to new base occurs automatically.	

### **Maximum Link Attempts**

The Maximum Link Attempts setting controls the number of times the scanner tries to form a connection with a base or an Access Point. During the connection setup process, the scanner transmits in order to search for and connect to a base or an Access Point. In order to prevent continuous transmissions that could interfere with other users of the ISM band, the number



---

of attempts to connect is limited by this setting. After the maximum number of attempts is reached, the scanner will not attempt to reconnect to a base or an Access Point. Pressing the trigger, scanning an Access Point linking bar code, or placing the scanner in the cradle resets the attempt count and the scanner will again try to link.

Scan the **Maximum Link Attempts** bar code, then scan the number of attempts for the setting (from 0-100) from the inside back cover. Scan Save to save the setting. *Default = 0.*



BT\_MLA.  
**Maximum Link Attempts**

*Note: When Auto Reconnect Mode is On, setting Maximum Link Attempts to zero will cause the scanner to try to link until the Power Time-Out Timer setting (see [page 3-15](#)) expires. When Auto Reconnect Mode is Off, setting Maximum Link Attempts to zero will cause the scanner to only attempt linking one time after a trigger pull.*

## **Relink Time-Out**

Relink Time-Out controls the idle time between relink attempts. An attempt to link a scanner to a base or an Access Point typically lasts up to 5 seconds. This is the time when the scanner is actually attempting a contact. Relink Time-Out controls the amount of time, in seconds, that elapses between the end of one connection attempt and the start of the next.

*Note: The length of time for an attempt depends on the number of scanners connected to a base unit or Access Point. An extra 7 seconds may be required when a connection is successful.*

Scan the **Relink Time-Out** bar code, then scan the number of seconds for the setting (from 1-100) from the inside back cover. Scan Save to save the setting. *Default = 3 seconds.*



BT\_RLT.  
**Relink Time-Out**

## **Bluetooth/ISM Network Activity Examples**

### **Default values**

When the scanner goes out of range, the scanner repeatedly attempts to connect to the base unit or Access Point. Each attempt consists of approximately 5 seconds of active time followed by 3 seconds of idle time. After one hour, the scanner powers off and batch mode data is lost.

**Maximum Link Attempts set to 15**  
**Other values at default setting**

---

When the scanner goes out of range, 15 attempts are made to link to the base unit or Access Point. Each attempt consists of approximately 5 seconds of active time followed by 3 seconds of idle time. After 15 cycles ( $8 \times 15 = 120$ ), or about 2 minutes, the scanner stops trying to connect to the base or Access Point, but retains any bar codes that may have been saved in batch mode. After one hour, the scanner powers off and batch mode data is lost.

**Auto Reconnect Mode set to 0**  
**Maximum Link Attempts set to 15**  
**Other values at default setting**

When the scanner goes out of range, no action is taken to relink. When the trigger is pulled, 15 attempts are made to link to the base or Access Point. Each attempt consists of approximately 5 seconds of active time followed by 3 seconds of idle time. After 15 cycles ( $8 \times 15 = 120$ ), or about 2 minutes, the scanner stops trying to connect to the base or Access Point, but retains any bar codes that may have been saved in batch mode. After one hour, the scanner powers off and batch mode data is lost. Refer to [Auto Reconnect Mode](#), page 3-33, to review other events that can start the relink process.

**Auto Reconnect Mode set to 1**  
**Maximum Link Attempts set to 0**  
**Relink Time-Out set to 10**  
**Scanner Power Time-Out Timer set to 1800**

*Note: See [Use this selection to set a time-out \(in milliseconds\) of the scanner's trigger when using serial commands to trigger the scanner](#). Once the scanner has timed out, you can activate the scanner either by pressing the trigger or using a serial trigger command. After scanning the Read Time-Out bar code, set the time-out duration (from 0-300,000 milliseconds) by scanning digits on the [Programming Chart inside the back cover](#), then scanning Save. Default = 30,000 ms. on page 4-8.*

The scanner attempts to connect to the base or Access Point every 15 seconds, measured from one attempt start to the next attempt start. After one half hour, the scanner powers off.

## **Host Command Acknowledgment**

Some applications require that the host terminal (or server) approve or reject incoming bar code data and notify the operator of these actions. These applications require that the host maintain control over the response indicators emitted from the scanner. Turning on Host ACK configures the scanner to respond to commands from the host system.

*Note: System performance degrades when using Host ACK at rates lower than 9600 baud.*

The following criteria must be met for the Host ACK to work correctly:

- The cordless system must be configured for Host Port RS232 (terminal ID = 000) or USB COM Emulation (terminal ID = 130).
- RTS/CTS is defaulted off. You must enable it if the host system requires it.

- 
- Host ACK must be set to On ([page 3-38](#)).
  - The host terminal software must be capable of interpreting the bar code data, make decisions based on the data content, and send out appropriate escape commands to the scanner.

Escape commands are addressed to the scanner via “Application Work Groups.” Once a command is sent, all scanners in a group respond to that command. Because of this, **it is recommended that each scanner is assigned to its own group in Host ACK mode.**

The commands to which the scanner responds are listed on [page 3-38](#). The **<ESC>** is a **1B** in hex. A typical command string is **y <ESC> x**, where “y” is the application work group number, “<ESC> x” is the escape command, and the comma is the terminator, which is required.

Commands may be strung together to create custom response sequences. An example of a command string is listed below.

0<ESC>4<ESC>5<ESC>6,

The above example will make a scanner in application work group zero beep low, then medium, then high.

Once Host ACK is enabled, the system works as follows:

- The scanner reads a code and sends data to the base or Access Point to transmit to the host system. No audible or visual indication is emitted until the scanner receives an escape command. The scanner read illumination goes out when there’s a successful read.
- Scanner operation is suspended until 1) a valid escape string is received from the host system (via the base or Access Point) or 2) the scanner times out.
- Once condition 1 or 2 above has been met, the scanner is ready to scan again, and the process repeats.

A time-out occurs if the scanner does not receive a valid escape command within 10 seconds. A time-out is indicated by an error tone. If a time-out occurs, the operator should check the host system to understand why a response to the scanner was not received.

---

## Host ACK On/Off



HSTACK1.  
Host ACK On



HSTACK0.  
\* Host ACK Off

## Host ACK Responses

Command	Action
<ESC> a	Double beeps to indicate a successful menu change was made.
<ESC> b	Razz or error tone to indicate a menu change was unsuccessful.
<ESC> 1	The green LED illuminates for 135 milliseconds followed by a pause.
<ESC> 2	The green LED illuminates for 2 seconds followed by a pause.
<ESC> 3	The green LED illuminates for 5 seconds followed by a pause.
<ESC> 4	Emits a beep at a low pitch.
<ESC> 5	Emits a beep at a medium pitch.
<ESC> 6	Emits a beep at a high pitch.
<ESC> 7	Beeps to indicate a successful decode and communication to host.
<ESC> 8	Razz or error tone to indicate a decode/communication to host was unsuccessful.

## Input/Output Settings

### Power Up Beeper

The scanner can be programmed to beep when it's powered up. If you are using a cordless system, the base can also be programmed to beep when it is powered up. Scan the **Off** bar code(s) if you don't want a power up beep. *Default = Power Up Beeper On - Scanner.*



BEPWPWR0.

**Power Up Beeper Off -  
Scanner**



BEPWPWR1.

**\* Power Up Beeper On -  
Scanner**



BASPWR0.

**Power Up Beeper Off -  
Cordless Base**



BASPWR1.

**Power Up Beeper On -  
Cordless Base**

### Beep on BEL Character

You may wish to force the scanner to beep upon a command sent from the host. If you scan the **Beep on BEL On** bar code below, the scanner will beep every time a BEL character is received from the host. *Default = Beep on BEL Off.*



BELBEP0.

**\*Beep on BEL Off**



BELBEP1.

**Beep on BEL On**

---

## Trigger Click

To hear an audible click every time the scanner trigger is pressed, scan the **Trigger Click On** bar code below. Scan the **Trigger Click Off** code if you don't wish to hear the click. (This feature has no effect on serial or automatic triggering.) *Default = Trigger Click Off.*



BEPTRG0.

\*Trigger Click Off



BEPTRG1.

Trigger Click On

## Good Read and Error Indicators

### Beeper – Good Read

The beeper may be programmed **On** or **Off** in response to a good read. Turning this option off, only turns off the beeper response to a good read indication. All error and menu beeps are still audible. *Default = Beeper - Good Read On.*



BEPBEP0.

Beeper - Good Read Off



BEPBEP1.

\* Beeper - Good Read On

---

## ***Beeper Volume – Good Read***

The beeper volume codes modify the volume of the beep the scanner emits on a good read. *Default = High.*



BEPLVL1.  
**Low**



BEPLVL2.  
**Medium**



BEPLVL3.  
**\* High**



BEPLVLO.  
**Off**

## ***Beeper Pitch – Good Read***

The beeper pitch codes modify the pitch (frequency) of the beep the scanner emits on a good read. *Default = Medium.*



BEPFQ11600.  
**Low (1600 Hz)**



BEPFQ12700.  
**\* Medium (2700 Hz)**



BEPFQ14200.  
**High (4200 Hz)**

---

## ***Beeper Pitch – Error***

The beeper pitch codes modify the pitch (frequency) of the sound the scanner emits when there is a bad read or error. *Default = Razz.*



BEPFQ2250.  
\* Razz (250 Hz)



BEPFQ23250.  
Medium (3250 Hz)



BEPFQ24200.  
High (4200 Hz)

## ***Beeper Duration – Good Read***

The beeper duration codes modify the length of the beep the scanner emits on a good read. *Default = Normal.*



BEPBIP0.  
\* Normal Beep



BEPBIP1.  
Short Beep

## ***LED – Good Read***

The LED indicator can be programmed **On** or **Off** in response to a good read. *Default = On.*



BEPLED1.  
\* LED - Good Read On



BEPLED0.  
LED - Good Read Off



---

## **Number of Beeps – Good Read**

The number of beeps of a good read can be programmed from 1 - 9. The same number of beeps will be applied to the beeper and LED in response to a good read. For example, if you program this option to have five beeps, there will be five beeps and five LED flashes in response to a good read. The beeps and LED flashes are in sync with one another. To change the number of beeps, scan the bar code below and then scan a digit (1-9) bar code and the **Save** bar code on the [Programming Chart](#) inside the back cover of this manual. *Default = 1.*



**Number of Good Read Beeps/LED Flashes**

## **Number of Beeps – Error**

The number of beeps and LED flashes emitted by the scanner for a bad read or error can be programmed from 1 - 9. For example, if you program this option to have five error beeps, there will be five error beeps and five LED flashes in response to an error. To change the number of error beeps, scan the bar code below and then scan a digit (1-9) bar code and the **Save** bar code on the [Programming Chart](#) inside the back cover of this manual. *Default = 1.*



**Number of Error Beeps/LED Flashes**

---

## Good Read Delay

This sets the minimum amount of time before the scanner can read another bar code. *Default = 0 ms (No Delay).*



DLYGRD0.

\* No Delay



DLYGRD500.

Short Delay (500 ms)



DLYGRD1000.

Medium Delay (1,000 ms)



DLYGRD1500.

Long Delay (1,500 ms)

## User-Specified Good Read Delay

If you want to set your own length for the good read delay, scan the bar code below, then set the delay (from 0-30,000 milliseconds) by scanning digits from the inside back cover, then scanning **Save**.



DLYGRD.

User-Specified Good Read Delay

## Manual Trigger Modes

When in manual trigger mode, the scanner scans until a bar code is read, or until the trigger is released. Two modes are available, **Normal** and **Enhanced**. Normal mode offers good scan speed and the longest working ranges (depth of field). Enhanced mode will give you the highest possible scan speed but

---

slightly less range than Normal mode. Enhanced mode is best used when you require a very fast scan speed and don't require a long working range. *Default = Manual Trigger-Normal.*



PAPHHF.

\* Manual Trigger - Normal



PAPHHS.

Manual Trigger - Enhanced

## **LED Illumination - Manual Trigger**

If you wish to set the illumination LED brightness, scan one of the bar codes below. This sets the LED illumination for the scanner when the trigger is pressed. *Default = High.*

*Note: The LEDs are like a flash on a camera. The lower the ambient light in the room, the brighter the LEDs need to be so the scanner can "see" the bar codes.*



PWRNOLD.

Off



PWRNOL100.

Low



PWRNOL150.

\* High

## **Serial Trigger Mode**

You can activate the scanner either by pressing the trigger, or using a serial trigger command (see [Trigger Commands](#) on page 11-4). When in serial mode, the scanner scans until a bar code has been read or until the deactivate command is sent. The scanner can also be set to turn itself off after a specified time has elapsed (see [Read Time-Out](#), which follows).

### **Read Time-Out**

Use this selection to set a time-out (in milliseconds) of the scanner's trigger when using serial commands to trigger the scanner. Once the scanner has timed out, you can activate the scanner either by pressing the trigger or using a serial trigger command. After scanning the **Read Time-Out** bar

---

code, set the time-out duration (from 0-300,000 milliseconds) by scanning digits on the [Programming Chart](#) inside the back cover, then scanning **Save**. *Default = 30,000 ms.*



## ***Presentation Mode***

Presentation Mode uses ambient light to detect bar codes. The LEDs remain off until a bar code is presented to the scanner, then the LEDs turn on automatically to read the code. If the light level in the room is not high enough, Presentation Mode may not work properly.

*Note: If you are using a cordless charge base in Presentation Mode, the battery will not charge unless the power supply is plugged into the base's auxiliary power port.*



---

## LED Illumination - Presentation Mode

If you wish to set the illumination LED brightness, scan one of the bar codes below. This sets the LED illumination for the scanner when it is in Presentation Mode. (If the scanner is triggered manually, the LED illumination will switch to the setting for a manual trigger. See [LED Illumination - Manual Trigger](#) on page 4-7.) *Default = High.*

*Note: The LEDs are like a flash on a camera. The lower the ambient light in the room, the brighter the LEDs need to be so the scanner can “see” the bar codes.*



PWRLDC0.  
**Off**



PWRLDC100.  
**Low**



PWRLDC150.  
**\* High**

*Note: LED Illumination - Presentation Mode does not apply to [Streaming Presentation™ Mode](#) or [Mobile Phone Read Mode](#).*

## Presentation LED Behavior after Decode

When a scanner is in presentation mode, the LEDs dim 30 seconds after a bar code is decoded. If you wish to dim the LEDs immediately after a bar code is decoded, scan the **LEDs Off** bar code, below. *Default = LEDs On.*



TRGPCK1.  
**\* LEDs On**



TRGPCK0.  
**LEDs Off**

---

## ***Presentation Sensitivity***

Presentation Sensitivity is a numeric range that increases or decreases the scanner's reaction time to bar code presentation. To set the sensitivity, scan the **Sensitivity** bar code, then scan the degree of sensitivity (from 0-20) from the inside back cover, and **Save**. 0 is the most sensitive setting, and 20 is the least sensitive. *Default = 1.*



TRGPMS.  
**Sensitivity**

## ***Presentation Centering***

Use Presentation Centering to narrow the scanner's field of view when it is in the stand to make sure the scanner reads only those bar codes intended by the user. For instance, if multiple codes are placed closely together, Presentation Centering will insure that only the desired codes are read.

*Note: To adjust centering when the scanner is hand-held, see [Centering](#) (page 4-18).*

If a bar code is not touched by a predefined window, it will not be decoded or output by the scanner. If Presentation Centering is turned on by scanning **Presentation Centering On**, the scanner only reads codes that pass through the centering window you specify using the **Top of Presentation Centering Window**, **Bottom of Presentation Centering Window**, **Left**, and **Right of Presentation Centering Window** bar codes.

In the example below, the white box is the centering window. The centering window has been set to 20% left, 30% right, 8% top, and 25% bottom. Since Bar Code 1 passes through the centering window, it will be read. Bar Code 2 does not pass through the centering window, so it will not be read.

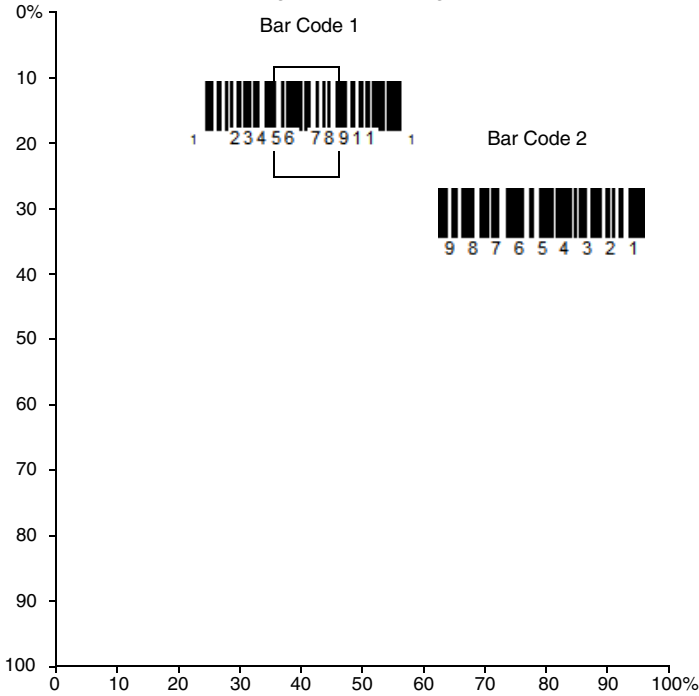

*Note: A bar code needs only to be touched by the centering window in order to be read. It does not need to pass completely through the centering window.*

---

Scan **Presentation Centering On**, then scan one of the following bar codes to change the top, bottom, left, or right of the centering window. Then scan the percent you want to shift the centering window using digits on the inside back cover of this manual. Scan **Save**. *Default Presentation Centering = 40% for Top and Left, 60% for Bottom and Right.*



PDCWIN1.

**Presentation Centering On**



PDCTOP.

**Top of Presentation Centering Window**



PDCLFT.

**Left of Presentation Centering Window**



PDCWIND.

**\* Presentation Centering Off**



PDCBOT.

**Bottom of Presentation Centering Window**



PDCRGT.

**Right of Presentation Centering Window**

## ***In-Stand Sensor Mode***

This feature senses when the scanner is removed from the stand and tells it to begin manual triggering. When **Sensor On** is enabled, the scanner defaults to Streaming Presentation Mode when it is in the stand, and to Manual Trigger Mode when it is removed from the stand. *Default = Sensor On.*



TRGSSW1.

**\* Sensor On**



TRGSSWD.

**Sensor Off**

*Note: If you are taking images (see [Imaging Commands](#) beginning on page 8-1), you must set the In-Stand Sensor to **Off**.*



---

You may program a Streaming Presentation Mode (Normal, Enhanced, or Mobile Phone) you wish to use for in-stand scanning, and a Manual Trigger mode (Normal, Enhanced, or Mobile Phone) you wish to use for out-of-stand scanning. To do this, you must first scan the preferred Streaming Presentation mode (see below), then scan the Manual Trigger mode (see [page 4-6](#) and [page 4-14](#)) you want to use.

## CodeGate®

When CodeGate is **On**, the trigger is used to allow decoded data to be transmitted to the host system. The scanner remains on, scanning and decoding bar codes, but the bar code data is not transmitted until the trigger is pressed. When CodeGate is **Off**, bar code data is transmitted when it is decoded.  
*Default = CodeGate Off Out-of-Stand.*



AOSCGD0.

\* CodeGate Off  
Out-of-Stand



AOSCGD1.

CodeGate On  
Out-of-Stand

## Streaming Presentation™ Mode

When in Streaming Presentation mode, the scanner's aimer goes out after a short time, but the scan illumination remains on all the time to continuously search for bar codes. Two modes are available, **Normal** and **Enhanced**. Normal mode offers good scan speed and the longest working ranges (depth of field). Enhanced mode will give you the highest possible scan speed but slightly less range than Normal mode. Enhanced mode is best used when you require a very fast scan speed and don't require a long working range.



PAPSPN.

Streaming Presentation Mode  
- Normal



PAPSPE.

Streaming Presentation Mode  
- Enhanced

When using [Preferred Symbology](#) (page 4-20), a lower priority symbol must be centered on the aiming pattern to be read in Streaming Presentation Mode.

---

You cannot take images when in Streaming Presentation Mode. To take images, scan [Image Snap and Ship](#) (see page 4-15).

*Note: If you are using a cordless charge base, it must have an external power supply plugged into the aux port for Streaming Presentation to work properly.*

## **Streaming Presentation In-Stand Programming**

This option is available when using [In-Stand Sensor Mode](#), page 4-12. You may program a specific Streaming Presentation Mode for in-stand scanning, and a Manual Trigger mode for out-of-stand scanning. To do this, you must first scan the preferred Streaming Presentation mode (Normal, Enhanced, or Mobile Phone), then scan the Manual Trigger mode (Normal, Enhanced, or Mobile Phone) you want to use.

## **Mobile Phone Read Mode**

When this mode is selected, your scanner is optimized to read bar codes from mobile phone or other LED displays. However, the speed of scanning printed bar codes may be slightly lower when this mode is enabled. You can enable Mobile Phone Reading for either a hand held device, or for a hands-free (presentation) application.



PAPHHC.

**Hand Held Scanning - Mobile  
Phone**



PAPSPC.

**Streaming Presentation -  
Mobile Phone**

*Note: To turn off Mobil Phone Read Mode, scan a Manual or Serial Trigger Mode bar code (see page 4-6).*

---

## Image Snap and Ship

**Image Snap and Ship** tells the scanner to take a picture (rather than read a bar code) when the trigger is pressed. Once the picture is snapped, it is shipped to the host system as a jpeg file by default. To revert to bar code reading, you must change to a different trigger mode (see [Manual Trigger Modes](#) beginning on page 4-6).



TRGMOD6.

### Image Snap and Ship

*Note: You must use an RS232 interface to use this code. Otherwise, menu codes will not work until you send a serial command for [Manual Trigger Modes](#) (see page 11-18).*

## Hands Free Time-Out

The Scan Stand and Presentation Modes are referred to as “hands free” modes. If the scanner’s trigger is pulled when using a hands free mode, the scanner changes to manual trigger mode. You can set the time the scanner should remain in manual trigger mode by setting the Hands Free Time-Out. Once the time-out value is reached, (if there have been no further trigger pulls) the scanner reverts to the original hands free mode.

Scan the **Hands Free Time-Out** bar code, then scan the time-out duration (from 0-300,000 milliseconds) from the inside back cover, and **Save**. *Default = 5,000 ms.*



TRGPTO.

### Hands Free Time-Out

## Reread Delay

This sets the time period before the scanner can read the *same* bar code a second time. Setting a reread delay protects against accidental rereads of the same bar code. Longer delays are effective in minimizing accidental rereads.

---

Use shorter delays in applications where repetitive bar code scanning is required. Reread Delay only works when in [Presentation Mode](#) (see page 4-8). *Default = Medium.*



DLYRRD500.  
Short (500 ms)



DLYRRD750.  
\* Medium (750 ms)



DLYRRD1000.  
Long (1000 ms)



DLYRRD2000.  
Extra Long (2000 ms)

## User-Specified Reread Delay

If you want to set your own length for the reread delay, scan the bar code below, then set the delay (from 0-30,000 milliseconds) by scanning digits from the inside back cover, then scanning **Save**.



DLYRRD.  
User-Specified Reread Delay

## Illumination Lights

If you want the illumination lights on while reading a bar code, scan the **Lights On** bar code, below. However, if you want to turn just the lights off, scan the **Lights Off** bar code. *Default = Lights On.*

*Note: This setting does not affect the aimer light. The aiming light can be set using [Aimer Mode](#) (page 4-18).*



SCNLED1.  
\* Lights On



SCNLED0.  
Lights Off

---

## Aimer Delay

The aimer delay allows a delay time for the operator to aim the scanner before the picture is taken. Use these codes to set the time between when the trigger is pulled and when the picture is taken. During the delay time, the aiming light will appear, but the LEDs won't turn on until the delay time is over. *Default = Off.*



SCNDLY200.  
200 milliseconds



SCNDLY400.  
400 milliseconds



SCNDLY0.  
\* Off (no delay)

## User-Specified Aimer Delay

If you want to set your own length for the duration of the delay, scan the bar code below, then set the time-out by scanning digits (0 - 4,000 ms) from the [Programming Chart](#) inside the back cover of this manual, then scan **Save**.



SCNDLY.  
Delay Duration

## Scanner Time-Out

*Note: Scanner Time-Out applies only to corded scanners. It does not apply to cordless systems.*

Scanner Time-Out powers down the scanner after the unit has been idle for the specified time. To prevent the scanner from powering down, set this time-out to 0, or no timer. Scan **Scanner Time-Out**, then set the time-out by scanning digits (from 0 - 999,999 ms) from the inside back cover, then scanning **Save**. *Default = 1 ms.*



SDRTIM.  
Scanner Time-Out

---

## Aimer Mode

This feature allows you to turn the aimer on and off. When the Interlaced bar code is scanned, the aimer is interlaced with the illumination LEDs. *Default = Interlaced.*



## Centering

Use Centering to narrow the scanner's field of view to make sure that when the scanner is hand-held, it reads only those bar codes intended by the user. For instance, if multiple codes are placed closely together, centering will insure that only the desired codes are read. (Centering can be used in conjunction with [Aimer Delay](#), page 4-17, for the most error-free operation in applications where multiple codes are spaced closely together. Using the Aimer Delay and Centering features, the scanner can emulate the operation of older systems, such as linear laser bar code scanners.)

*Note: To adjust centering when the scanner is in the stand, see [Presentation Centering](#) (page 4-10).*

If a bar code is not touched by a predefined window, it will not be decoded or output by the scanner. If centering is turned on by scanning **Centering On**, the scanner only reads codes that pass through the centering window you specify using the **Top of Centering Window**, **Bottom of Centering Window**, **Left**, and **Right of Centering Window** bar codes.

In the example below, the white box is the centering window. The centering window has been set to 20% left, 30% right, 8% top, and 25% bottom. Since Bar Code 1 passes through the centering window, it will be read. Bar Code 2 does not pass through the centering window, so it will not be read.

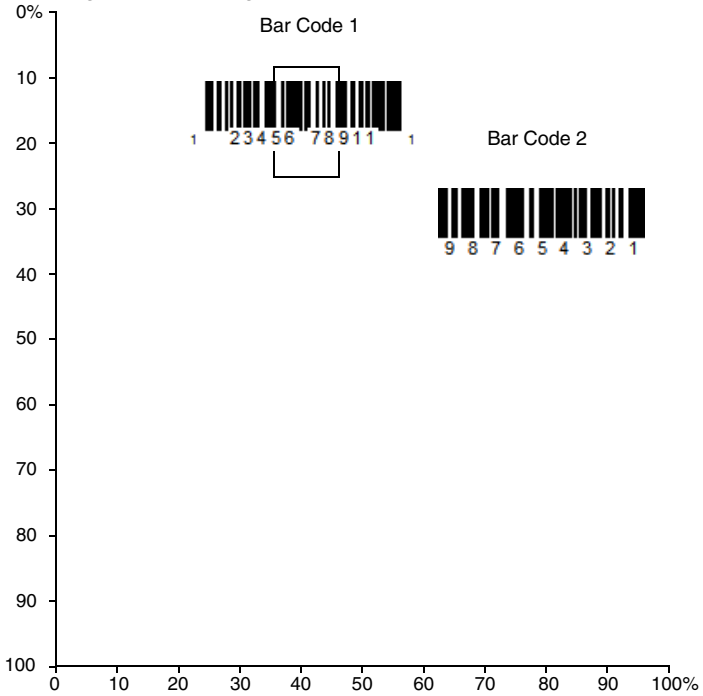

*Note: A bar code needs only to be touched by the centering window in order to be read. It does not need to pass completely through the centering window.*

---

Scan **Centering On**, then scan one of the following bar codes to change the top, bottom, left, or right of the centering window. Then scan the percent you want to shift the centering window using digits on the inside back cover of this manual. Scan **Save**. *Default Centering = 40% for Top and Left, 60% for Bottom and Right.*



DECWIN1.  
Centering On



DECTOP.  
Top of Centering Window



DECLFT.  
Left of Centering Window



DECWIND.  
\* Centering Off



DECBOT.  
Bottom of Centering Window



DECRGT.  
Right of Centering Window

## Preferred Symbology

The scanner can be programmed to specify one symbology as a higher priority over other symbologies in situations where both bar code symbologies appear on the same label, but the lower priority symbology cannot be disabled.

For example, you may be using the scanner in a retail setting to read U.P.C. symbols, but have occasional need to read a code on a drivers license. Since some licenses have a Code 39 symbol as well as the PDF417 symbol, you can use Preferred Symbology to specify that the PDF417 symbol be read instead of the Code 39.

Preferred Symbology classifies each symbology as **high priority**, **low priority**, or as an **unspecified type**. When a low priority symbology is presented, the scanner ignores it for a set period of time (see [Preferred Symbology Time-out](#) on page 4-21) while it searches for the high priority symbology. If a high priority symbology is located during this period, then that data is read immediately.

If the time-out period expires before a high priority symbology is read, the scanner will read any bar code in its view (low priority or unspecified). If there is no bar code in the scanner's view after the time-out period expires, then no data is reported.

*Note: A low priority symbol must be centered on the aiming pattern to be read.*



---

Scan a bar code below to enable or disable Preferred Symbology. *Default = Preferred Symbology Off.*



PRFENA1.

**Preferred Symbology On**



PRFENAO.

**\* Preferred Symbology Off**

## ***High Priority Symbology***

To specify the high priority symbology, scan the High Priority Symbology bar code below. On the [Symbology Chart](#) on page A-1, find the symbology you want to set as high priority. Locate the Hex value for that symbology and scan the 2 digit hex value from the Programming Chart (inside back cover). Scan **Save** to save your selection. *Default = None*



PRFCOD.

**High Priority Symbology**

## ***Low Priority Symbology***

To specify the low priority symbology, scan the Low Priority Symbology bar code below. On the [Symbology Chart](#) on page A-1, find the symbology you want to set as low priority. Locate the Hex value for that symbology and scan the 2 digit hex value from the Programming Chart (inside back cover).

If you want to set additional low priority symbologies, scan **FF**, then scan the 2 digit hex value from the Programming Chart for the next symbology. You can program up to 5 low priority symbologies. Scan **Save** to save your selection. *Default = None*



PRFBLK.

**Low Priority Symbology**

## ***Preferred Symbology Time-out***

Once you have enabled Preferred Symbology and entered the high and low priority symbologies, you must set the time-out period. This is the period of time the scanner will search for a high priority bar code after a low priority

---

bar code has been encountered. Scan the bar code below, then set the delay (from 1-3,000 milliseconds) by scanning digits from the inside back cover, then scanning **Save**. *Default = 500 ms.*



PRFPTO.

**Preferred Symbology Time-out**

## ***Preferred Symbology Default***

Scan the bar code below to set all Preferred Symbology entries to their default values.



PRFDFT.

**Preferred Symbology Default**

## ***Output Sequence Overview***

### ***Require Output Sequence***

When turned off, the bar code data will be output to the host as the scanner decodes it. When turned on, all output data must conform to an edited sequence or the scanner will not transmit the output data to the host device.

*Note: This selection is unavailable when the Multiple Symbols Selection is turned on.*

### ***Output Sequence Editor***

This programming selection allows you to program the scanner to output data (when scanning more than one symbol) in whatever order your application requires, regardless of the order in which the bar codes are scanned. Reading the **Default Sequence** symbol programs the scanner to the Universal values, shown below. These are the defaults. Be **certain** you want to delete or clear all formats before you read the **Default Sequence** symbol.

*Note: To make Output Sequence Editor selections, you'll need to know the code I.D., code length, and character match(es) your application requires. Use the Alphanumeric symbols (inside back cover) to read these options. You must hold the trigger while reading each bar code in the sequence.*

---

## To Add an Output Sequence

1. Scan the **Enter Sequence** symbol (see [Require Output Sequence](#), page 4-26).
2. **Code I.D.**  
On the [Symbology Chart](#) on page A-1, find the symbology to which you want to apply the output sequence format. Locate the Hex value for that symbology and scan the 2 digit hex value from the Programming Chart (inside back cover).
3. **Length**  
Specify what length (up to 9999 characters) of data output will be acceptable for this symbology. Scan the four digit data length from the Programming Chart. (Note: 50 characters is entered as 0050. 9999 is a universal number, indicating all lengths.) When calculating the length, you must count any programmed prefixes, suffixes, or formatted characters as part of the length (unless using 9999).
4. **Character Match Sequences**  
On the [ASCII Conversion Chart \(Code Page 1252\)](#), page A-4, find the Hex value that represents the character(s) you want to match. Use the Programming Chart to read the alphanumeric combination that represents the ASCII characters. (99 is the Universal number, indicating all characters.)
5. **End Output Sequence Editor**  
Scan **FF** to enter an Output Sequence for an additional symbology, or **Save** to save your entries.

## Other Programming Selections

- **Discard**  
This exits without saving any Output Sequence changes.

---

## Output Sequence Example

In this example, you are scanning Code 93, Code 128, and Code 39 bar codes, but you want the scanner to output Code 39 1st, Code 128 2nd, and Code 93 3rd, as shown below.

*Note: Code 93 must be enabled to use this example.*



A - Code 39



B - Code 128



C - Code 93

You would set up the sequence editor with the following command line:

```
SEQBLK62999941FF6A999942FF69999943FF
```

The breakdown of the command line is shown below:

SEQBLKsequence editor start command

62 code identifier for **Code 39**

9999 code length that must match for Code 39, 9999 = all lengths

41 start character match for Code 39, 41h = "A"

FF termination string for first code

6A code identifier for **Code 128**

9999 code length that must match for Code 128, 9999 = all lengths

42 start character match for Code 128, 42h = "B"

FF termination string for second code

69 code identifier for **Code 93**

9999 code length that must match for Code 93, 9999 = all lengths

43 start character match for Code 93, 43h = "C"

FF termination string for third code

To program the previous example using specific lengths, you would have to count any programmed prefixes, suffixes, or formatted characters as part of the length. If you use the example on [page 4-24](#), but assume a <CR> suffix and specific code lengths, you would use the following command line:

```
SEQBLK62001241FF6A001342FF69001243FF
```

The breakdown of the command line is shown below:

---

SEQBLKsequence editor start command

62 code identifier for **Code 39**  
0012 A - Code 39 sample length (11) plus CR suffix (1) = 12  
41 start character match for Code 39, 41h = "A"  
FF termination string for first code  
6A code identifier for **Code 128**  
0013 B - Code 128 sample length (12) plus CR suffix (1) = 13  
42 start character match for Code 128, 42h = "B"  
FF termination string for second code  
69 code identifier for **Code 93**  
0012 C - Code 93 sample length (11) plus CR suffix (1) = 12  
43 start character match for Code 93, 43h = "C"  
FF termination string for third code

### ***Output Sequence Editor***



SEQBLK.  
**Enter Sequence**



SEQDFT.  
**Default Sequence**

### ***Partial Sequence***

If an output sequence operation is terminated before all your output sequence criteria are met, the bar code data acquired to that point is a "partial sequence."

Scan **Discard Partial Sequence** to discard partial sequences when the output sequence operation is terminated before completion. Scan **Transmit Partial Sequence** to transmit partial sequences. (Any fields in the sequence where no data match occurred will be skipped in the output.)



SEQTTS1.  
**Transmit Partial Sequence**



SEQTTS0.  
**\* Discard Partial Sequence**

---

## Require Output Sequence

When an output sequence is **Required**, all output data must conform to an edited sequence or the scanner will not transmit the output data to the host device. When it's **On/Not Required**, the scanner will attempt to get the output data to conform to an edited sequence but, if it cannot, the scanner transmits all output data to the host device as is.

When the output sequence is **Off**, the bar code data is output to the host as the scanner decodes it. *Default = Off.*

*Note: This selection is unavailable when the Multiple Symbols Selection is turned on.*



SEQ\_EN2.

**Required**



SEQ\_EN1.

**On/Not Required**



SEQ\_EN0.

**\*Off**

## Multiple Symbols

When this programming selection is turned **On**, it allows you to read multiple symbols with a single pull of the scanner's trigger. If you press and hold the trigger, aiming the scanner at a series of symbols, it reads unique symbols once, beeping (if turned on) for each read. The scanner attempts to find and decode new symbols as long as the trigger is pulled. When this programming selection is turned **Off**, the scanner will only read the symbol closest to the aiming beam. *Default = Off.*



SHOTGN1.

**On**



SHOTGN0.

**\* Off**

---

## No Read

With No Read turned **On**, the scanner notifies you if a code cannot be read. If using an EZConfig-Scanning Tool Scan Data Window (see page 10-3), an “NR” appears when a code cannot be read. If No Read is turned **Off**, the “NR” will not appear. *Default = Off.*



SHWNRD1.

**On**



SHWNRD0.

**\* Off**

If you want a different notation than “NR,” for example, “Error,” or “Bad Code,” you can edit the output message (see [Data Formatting](#) beginning on page 6-1). The hex code for the No Read symbol is 9C.

## Video Reverse

Video Reverse is used to allow the scanner to read bar codes that are inverted. The **Video Reverse Off** bar code below is an example of this type of bar code. Scan **Video Reverse Only** to read *only* inverted bar codes. Scan **Video Reverse and Standard Bar Codes** to read both types of codes.

*Note: After scanning **Video Reverse Only**, menu bar codes cannot be read. You must scan **Video Reverse Off** or **Video Reverse and Standard Bar Codes** in order to read menu bar codes.*

*Note: Images downloaded from the unit are not reversed. This is a setting for decoding only.*



VIDREV1.

**Video Reverse Only**



VIDREV2

**Video Reverse and Standard Bar Codes**



VIDREV0.

**\* Video Reverse Off**

## Working Orientation

Some bar codes are direction-sensitive. For example, KIX codes and OCR can misread when scanned sideways or upside down. Use the working orientation settings if your direction-sensitive codes will not usually be presented upright to the scanner. *Default = Upright.*

Upright:



Upside Down:



Vertical, Top to Bottom:  
(Rotate CW 90°)

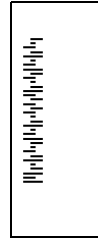

Vertical, Bottom to Top:  
(Rotate CCW 90°)

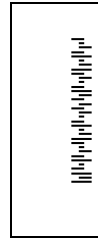

*Default = Upright.*



ROTATN0.

\* Upright



ROTATN1.

Vertical, Bottom to Top



ROTATN2.

Upside Down



ROTATN3.

Vertical, Top to Bottom



## Prefix/Suffix Overview

When a bar code is scanned, additional information is sent to the host computer along with the bar code data. This group of bar code data and additional, user-defined data is called a “message string.” The selections in this section are used to build the user-defined data into the message string.

Prefix and Suffix characters are data characters that can be sent before and after scanned data. You can specify if they should be sent with all symbologies, or only with specific symbologies. The following illustration shows the breakdown of a message string:

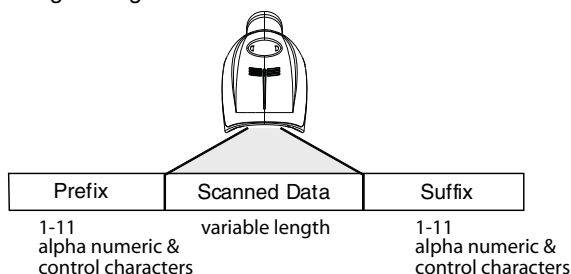

## Points to Keep In Mind

- It is not necessary to build a message string. The selections in this chapter are only used if you wish to alter the default settings. *Default prefix = None. Default suffix = None.*
- A prefix or suffix may be added or cleared from one symbology or all symbologies.
- You can add any prefix or suffix from the [ASCII Conversion Chart \(Code Page 1252\)](#), beginning on page A-4, plus Code I.D. and AIM I.D.
- You can string together several entries for several symbologies at one time.
- Enter prefixes and suffixes in the order in which you want them to appear on the output.
- When setting up for specific symbologies (as opposed to all symbologies), the specific symbology ID value counts as an added prefix or suffix character.
- The maximum size of a prefix or suffix configuration is 200 characters, which includes header information.

## To Add a Prefix or Suffix:

**Step 1.** Scan the **Add Prefix** or **Add Suffix** symbol ([page 5-3](#)).

**Step 2.** Determine the 2 digit Hex value from the Symbology Chart (included in the [Symbology Chart](#), beginning on page A-1) for the

---

symbology to which you want to apply the prefix or suffix. For example, for Code 128, Code ID is “j” and Hex ID is “6A”.

- Step 3.** Scan the 2 hex digits from the [Programming Chart](#) inside the back cover of this manual or scan **9, 9** for all symbologies.
- Step 4.** Determine the hex value from the [ASCII Conversion Chart \(Code Page 1252\)](#), beginning on page A-4, for the prefix or suffix you wish to enter.
- Step 5.** Scan the 2 digit hex value from the [Programming Chart](#) inside the back cover of this manual.
- Step 6.** Repeat Steps 4 and 5 for every prefix or suffix character.
- Step 7.** To add the Code I.D., scan **5, C, 8, 0**.  
To add AIM I.D., scan **5, C, 8, 1**.  
To add a backslash (\), scan **5, C, 5, C**.

*Note: To add a backslash (\) as in Step 7, you must scan 5C twice – once to create the leading backslash and then to create the backslash itself.*

- Step 8.** Scan **Save** to exit and save, or scan **Discard** to exit without saving. Repeat Steps 1-6 to add a prefix or suffix for another symbology.

### ***Example: Add a Suffix to a specific symbology***

To send a CR (carriage return) Suffix for U.P.C. only:

- Step 1.** Scan **Add Suffix**.
- Step 2.** Determine the 2 digit hex value from the Symbology Chart (included in the [Symbology Chart](#), beginning on page A-1) for U.P.C..
- Step 3.** Scan **6, 3** from the [Programming Chart](#) inside the back cover of this manual.
- Step 4.** Determine the hex value from the [ASCII Conversion Chart \(Code Page 1252\)](#), beginning on page A-4, for the CR (carriage return).
- Step 5.** Scan **0, D** from the [Programming Chart](#) inside the back cover of this manual.
- Step 6.** Scan **Save**, or scan **Discard** to exit without saving.

### ***To Clear One or All Prefixes or Suffixes***

You can clear a single prefix or suffix, or clear all prefixes/suffixes for a symbology. If you have been entering prefixes and suffixes for single symbologies, you can use **Clear One Prefix (Suffix)** to delete a specific character from a symbology. When you **Clear All Prefixes (Suffixes)**, all the prefixes or suffixes for a symbology are deleted.

- 
- Step 1.** Scan the **Clear One Prefix** or **Clear One Suffix** symbol.
  - Step 2.** Determine the 2 digit Hex value from the Symbology Chart (included in the [Symbology Chart](#), beginning on page A-1) for the symbology from which you want to clear the prefix or suffix.
  - Step 3.** Scan the 2 digit hex value from the [Programming Chart](#) inside the back cover of this manual or scan **9, 9** for all symbologies.

Your change is automatically saved.

### ***To Add a Carriage Return Suffix to All Symbologies***

Scan the following bar code if you wish to add a carriage return suffix to all symbologies at once. This action first clears all current suffixes, then programs a carriage return suffix for all symbologies.



VSUFCR.  
**Add CR Suffix  
All Symbologies**

### ***Prefix Selections***



PREBK2.  
**Add Prefix**



PRECL2.  
**Clear One Prefix**



PRECA2.  
**Clear All Prefixes**

---

## Suffix Selections



SUFBK2.  
Add Suffix



SUFCL2.  
Clear One Suffix



SUFCA2.  
Clear All Suffixes

## Function Code Transmit

When this selection is enabled and function codes are contained within the scanned data, the scanner transmits the function code to the terminal. Charts of these function codes are provided in [Supported Interface Keys](#) starting on [page 9-3](#). When the scanner is in keyboard wedge mode, the scan code is converted to a key code before it is transmitted. *Default = Enable.*



RMVFNC0.  
\* Enable



RMVFNC1.  
Disable

## Intercharacter, Interfunction, and Intermessage Delays

Some terminals drop information (characters) if data comes through too quickly. Intercharacter, interfunction, and intermessage delays slow the transmission of data, increasing data integrity.

---

## Intercharacter Delay

An intercharacter delay of up to 5000 milliseconds (in 5ms increments) may be placed between the transmission of each character of scanned data. Scan the **Intercharacter Delay** bar code below, then scan the number of 5ms delays, and the **Save** bar code using the [Programming Chart](#) inside the back cover of this manual.

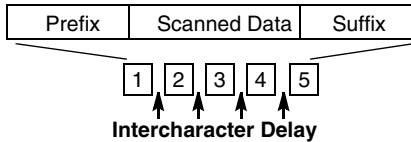

DLYCHR.

Intercharacter Delay

To remove this delay, scan the **Intercharacter Delay** bar code, then set the number of delays to 0. Scan the **Save** bar code using the [Programming Chart](#) inside the back cover of this manual.

*Note: Intercharacter delays are not supported in USB serial emulation.*

## User Specified Intercharacter Delay

An intercharacter delay of up to 5000 milliseconds (in 5ms increments) may be placed after the transmission of a particular character of scanned data. Scan the **Delay Length** bar code below, then scan the number of 5ms delays, and the **Save** bar code using the [Programming Chart](#) inside the back cover of this manual.

Next, scan the **Character to Trigger Delay** bar code, then the 2-digit hex value for the ASCII character that will trigger the delay [ASCII Conversion Chart \(Code Page 1252\)](#), beginning on page A-4.



DLYCRX.

Delay Length



DLY\_XX.

Character to Trigger Delay

To remove this delay, scan the **Delay Length** bar code, and set the number of delays to 0. Scan the **Save** bar code using the [Programming Chart](#) inside the back cover of this manual.

---

## Interfunction Delay

An interfunction delay of up to 5000 milliseconds (in 5ms increments) may be placed between the transmission of each segment of the message string. Scan the **Interfunction Delay** bar code below, then scan the number of 5ms delays, and the **Save** bar code using the [Programming Chart](#) inside the back cover of this manual.

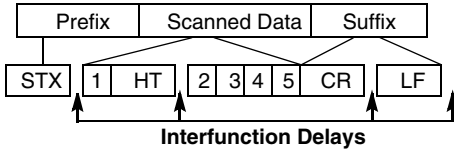

DLYFNC.

**Interfunction Delay**

To remove this delay, scan the **Interfunction Delay** bar code, then set the number of delays to 0. Scan the **Save** bar code using the [Programming Chart](#) inside the back cover of this manual.

## Intermessage Delay

An intermessage delay of up to 5000 milliseconds (in 5ms increments) may be placed between each scan transmission. Scan the **Intermessage Delay** bar code below, then scan the number of 5ms delays, and the **Save** bar code using the [Programming Chart](#) inside the back cover of this manual.

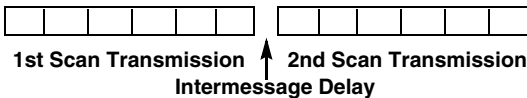

DLYMSG.

**Intermessage Delay**

To remove this delay, scan the **Intermessage Delay** bar code, then set the number of delays to 0. Scan the **Save** bar code using the [Programming Chart](#) inside the back cover of this manual.

## Data Format Editor Introduction

You may use the Data Format Editor to change the scanner's output. For example, you can use the Data Format Editor to insert characters at certain points in bar code data as it is scanned. The selections in the following pages are used only if you wish to alter the output. *Default Data Format setting = None.*

Normally, when you scan a bar code, it gets outputted automatically; however when you create a format, you must use a "send" command (see [Send Commands](#) on page 6-4) within the format program to output data.

Multiple formats may be programmed into the scanner. They are stacked in the order in which they are entered. However, the following list presents the order in which formats are applied:

1. Specific Terminal ID, Actual Code ID, Actual Length
2. Specific Terminal ID, Actual Code ID, Universal Length
3. Specific Terminal ID, Universal Code ID, Actual Length
4. Specific Terminal ID, Universal Code ID, Universal Length
5. Universal Terminal ID, Actual Code ID, Actual Length
6. Universal Terminal ID, Actual Code ID, Universal Length
7. Universal Terminal ID, Universal Code ID, Actual Length
8. Universal Terminal ID, Universal Code ID, Universal Length

The maximum size of a data format configuration is 2000 bytes, which includes header information.

If you have changed data format settings, and wish to clear all formats and return to the factory defaults, scan the **Default Data Format** code below.



DFMDF3.

\* Default Data Format

## Add a Data Format

**Step 1.** Scan the **Enter Data Format** symbol ([page 6-2](#)).

**Step 2.** Select **Primary/Alternate Format**

Determine if this will be your primary data format, or one of 3 alternate formats. This allows you to save a total of 4 different data formats. To program your primary format, scan **0** using the [Programming Chart](#) inside the back cover of this manual. If you are programming an alternate format, scan **1**, **2**, or **3**, depending on which alternate format

---

you are programming. (See [Primary/Alternate Data Formats](#) on page 6-11 for further information.)

### Step 3. Terminal Type

Refer to [Terminal ID Table](#) (page 6-4) and locate the Terminal ID number for your PC. Scan three numeric bar codes on the inside back cover to program the scanner for your terminal ID (you must enter 3 digits). For example, scan **0 0 3** for an AT wedge.

*Note: The wildcard for all terminal types is 099.*

### Step 4. Code I.D.

In the [Symbology Chart](#), beginning on page A-1, find the symbology to which you want to apply the data format. Locate the Hex value for that symbology and scan the 2 digit hex value from the [Programming Chart](#) inside the back cover of this manual.

*Note: If you wish to create a data format for all symbologies, with the exception of some specific symbologies, refer to B8 (page 6-9).*

*Note: If you are creating a data format for Batch Mode Quantity, use 35 for the Code I.D.*

### Step 5. Length

Specify what length (up to 9999 characters) of data will be acceptable for this symbology. Scan the four digit data length from the [Programming Chart](#) inside the back cover of this manual. (Note: 50 characters is entered as 0050. 9999 is a universal number, indicating all lengths.)

### Step 6. Editor Commands

Refer to [Data Format Editor Commands](#) (page 6-4). Scan the symbols that represent the command you want to enter. 94 alphanumeric characters may be entered for each symbology data format.

**Step 7.** Scan **Save** to save your data format, or **Discard** to exit without saving your changes.



MNUSAV.  
Save



DFMBK3.  
Enter Data Format



MNUABT.  
Discard



---

## Other Programming Selections

### Clear One Data Format

This deletes one data format for one symbology. If you are clearing the primary format, scan **0** from the [Programming Chart](#) inside the back cover of this manual. If you are clearing an alternate format, scan **1**, **2**, or **3**, depending on the format you are clearing. Scan the Terminal Type and Code I.D. (see [Symbology Chart](#) on page A-1), and the bar code data length for the specific data format that you want to delete. All other formats remain unaffected.

### Clear all Data Formats

This clears all data formats.

**Save** to exit and save your data format changes.

**Discard** to exit without saving any data format changes.



DFMCL3.

Clear One Data Format



DFMCA3.

Clear All Data Formats



MNUSAV.

Save



MNUABT.

Discard

---

## Terminal ID Table

<u>Terminal</u>	<u>Model(s)</u>	<u>Terminal ID</u>
IBM	PC/AT and compatibles	003
	USB SurePOS Handheld Scanner	128
	USB SurePOS Tabletop Scanner	129
RS232	True	000
	TTL	000
RS485		051
USB	Serial	130
	PC Keyboard	124
	Mac Keyboard	125
	Japanese Keyboard (PC)	134
	HID POS	131

## Data Format Editor Commands

### Send Commands

#### **Send all characters**

- F1 Include in the output message all of the characters from the input message, starting from current cursor position, followed by an insert character. *Syntax = F1xx* where xx stands for the insert character's hex value for its ASCII code.  
Refer to the [ASCII Conversion Chart \(Code Page 1252\)](#), beginning on page A-4 for decimal, hex and character codes.

#### **Send a number of characters**

- F2 Include in the output message a number of characters followed by an insert character. Start from the current cursor position and continue for "nn" characters or through the last character in the input message, followed by character "xx." *Syntax = F2nnxx* where nn stands for the numeric value (00-99) for the number of characters, and xx stands for the the insert character's hex value for its ASCII code.  
Refer to the [ASCII Conversion Chart \(Code Page 1252\)](#), beginning on page A-4 for decimal, hex and character codes.

#### **Send all characters up to a particular character**

- F3 Include in the output message all characters from the input message, starting with the character at the current cursor position and continuing to, but not including, the search character "ss," followed by an insert character. The cursor is moved forward to the "ss" character. *Syntax = F3ssxx* where ss stands for the search character's hex value for its

---

ASCII code, and xx stands for the insert character's hex value for its ASCII code.

Refer to the [ASCII Conversion Chart \(Code Page 1252\)](#), beginning on page A-4 for decimal, hex and character codes.

### ***Send all but the last characters***

- E9 Include in the output message all but the last “nn” characters, starting from the current cursor position. The cursor is moved forward to one position past the last input message character included. *Syntax = E9nn* where nn stands for the numeric value (00-99) for the number of characters that will not be sent at the end of the message.

### ***Insert a character multiple times***

- F4 Send “xx” character “nn” times in the output message, leaving the cursor in the current position. *Syntax = F4xxnn* where xx stands for the insert character's hex value for its ASCII code, and nn is the numeric value (00-99) for the number of times it should be sent. Refer to the [ASCII Conversion Chart \(Code Page 1252\)](#), beginning on page A-4 for decimal, hex and character codes.

### ***Insert symbology name***

- B3 Insert the name of the bar code's symbology in the output message, without moving the cursor. Only symbologies with a Honeywell ID are included (see [Symbology Chart](#) on page A-1). Refer to the [ASCII Conversion Chart \(Code Page 1252\)](#), beginning on page A-4 for decimal, hex and character codes.

### ***Insert bar code length***

- B4 Insert the bar code's length in the output message, without moving the cursor. The length is expressed as a numeric string and does not include leading zeroes.

### ***Insert key strokes***

- B5 Insert a key stroke or combination of key strokes. Key strokes are dependent on your keyboard (see [Unicode Key Maps](#) on page A-8). Any key can be inserted, including arrows and functions. *Syntax = B5xxssnn* where xx is the number of keys pressed (without key modifiers), ss is the key modifier from the table below, and nn is the key number from the [Unicode Key Maps](#), page A-8.

<b>Key Modifiers</b>	
No Key Modifier	00
Shift Left	01
Shift Right	02
Alt Left	04
Alt Right	08

Key Modifiers	
Control Left	10
Control Right	20

For example, B501021F inserts an “A” on a 104 key, U.S. style keyboard. B5 = the command, 01 = number of keys pressed (without the key modifier), 02 is the key modifier for Shift Right, and 1F is the “a” key. If a lower case “a” were to be inserted, B501001F would be entered.

If there are three keystrokes, the syntax would change from B5xxssnn for one keystroke to B5xxssnnssnnssnn. An example that would insert “abc” is as follows: B503001F00320030F833.

*Note: Key modifiers can be added together when needed. Example: Control Left+Shift Left = 11.*

## Move Commands

### **Move the cursor forward a number of characters**

- F5 Move the cursor ahead “nn” characters from current cursor position. *Syntax = F5nn* where nn is the numeric value (00-99) for the number of characters the cursor should be moved ahead.

### **Move the cursor backward a number of characters**

- F6 Move the cursor back “nn” characters from current cursor position. *Syntax = F6nn* where nn is the numeric value (00-99) for the number of characters the cursor should be moved back.

### **Move the cursor to the beginning**

- F7 Move the cursor to the first character in the input message. *Syntax = F7.*

### **Move the cursor to the end**

- EA Move the cursor to the last character in the input message. *Syntax = EA.*

## Search Commands

### **Search forward for a character**

- F8 Search the input message forward for “xx” character from the current cursor position, leaving the cursor pointing to the “xx” character. *Syntax = F8xx* where xx stands for the search character’s hex value for its ASCII code. Refer to the [ASCII Conversion Chart \(Code Page 1252\)](#), beginning on page A-4 for decimal, hex and character codes.

---

### ***Search backward for a character***

- F9 Search the input message backward for “xx” character from the current cursor position, leaving the cursor pointing to the “xx” character. *Syntax* = *F9xx* where xx stands for the search character’s hex value for its ASCII code.  
Refer to the [ASCII Conversion Chart \(Code Page 1252\)](#), beginning on page A-4 for decimal, hex and character codes.

### ***Search forward for a string***

- B0 Search forward for “s” string from the current cursor position, leaving cursor pointing to “s” string. *Syntax* = *B0nnnnS* where nnnn is the string length (up to 9999), and S consists of the ASCII hex value of each character in the match string. For example, *B0000454657374* will search forward for the first occurrence of the 4 character string “Test.” Refer to the [ASCII Conversion Chart \(Code Page 1252\)](#), beginning on page A-4 for decimal, hex and character codes.

### ***Search backward for a string***

- B1 Search backward for “s” string from the current cursor position, leaving cursor pointing to “s” string. *Syntax* = *B1nnnnS* where nnnn is the string length (up to 9999), and S consists of the ASCII hex value of each character in the match string. For example, *B1000454657374* will search backward for the first occurrence of the 4 character string “Test.” Refer to the [ASCII Conversion Chart \(Code Page 1252\)](#), beginning on page A-4 for decimal, hex and character codes.

### ***Search forward for a non-matching character***

- E6 Search the input message forward for the first non-“xx” character from the current cursor position, leaving the cursor pointing to the non-“xx” character. *Syntax* = *E6xx* where xx stands for the search character’s hex value for its ASCII code.  
Refer to the [ASCII Conversion Chart \(Code Page 1252\)](#), beginning on page A-4 for decimal, hex and character codes.

### ***Search backward for a non-matching character***

- E7 Search the input message backward for the first non-“xx” character from the current cursor position, leaving the cursor pointing to the non-“xx” character. *Syntax* = *E7xx* where xx stands for the search character’s hex value for its ASCII code.  
Refer to the [ASCII Conversion Chart \(Code Page 1252\)](#), beginning on page A-4 for decimal, hex and character codes.

---

## **Miscellaneous Commands**

### **Suppress characters**

- FB Suppress all occurrences of up to 15 different characters, starting at the current cursor position, as the cursor is advanced by other commands. When the FC command is encountered, the suppress function is terminated. The cursor is not moved by the FB command.  
Syntax = FBnnxxyy ..zz where nn is a count of the number of suppressed characters in the list, and xxyy .. zz is the list of characters to be suppressed.

### **Stop suppressing characters**

- FC Disables suppress filter and clear all suppressed characters. *Syntax = FC.*

### **Replace characters**

- E4 Replaces up to 15 characters in the output message, without moving the cursor. Replacement continues until the E5 command is encountered. *Syntax = E4nnxx<sub>1</sub>xx<sub>2</sub>yy<sub>1</sub>yy<sub>2</sub>...ZZ<sub>1</sub>ZZ<sub>2</sub>* where nn is the total count of the number of characters in the list (characters to be replaced plus replacement characters); xx<sub>1</sub> defines characters to be replaced and xx<sub>2</sub> defines replacement characters, continuing through zz<sub>1</sub> and zz<sub>2</sub>.

### **Stop replacing characters**

- E5 Terminates character replacement. *Syntax = E5.*

### **Compare characters**

- FE Compare the character in the current cursor position to the character "xx." If characters are equal, move the cursor forward one position. *Syntax = FExx* where xx stands for the comparison character's hex value for its ASCII code.  
Refer to the [ASCII Conversion Chart \(Code Page 1252\)](#), beginning on page A-4 for decimal, hex and character codes.

### **Compare string**

- B2 Compare the string in the input message to the string "s." If the strings are equal, move the cursor forward past the end of the string. *Syntax = B2nnnnS* where nnnn is the string length (up to 9999), and S consists of the ASCII hex value of each character in the match string. For example, B2000454657374 will compare the string at the current cursor position with the 4 character string "Test."  
Refer to the [ASCII Conversion Chart \(Code Page 1252\)](#), beginning on page A-4 for decimal, hex and character codes.

### **Check for a number**

- EC Check to make sure there is an ASCII number at the current cursor position. The format is aborted if the character is not numeric.

---

## Check for non-numeric character

- ED Check to make sure there is a non-numeric ASCII character at the current cursor position. The format is aborted if the character is numeric.

### Insert a delay

- EF Inserts a delay of up to 49,995 milliseconds (in multiples of 5), starting from the current cursor position. Syntax = EFnnnn where nnnn stands for the delay in 5ms increments, up to 9999. This command can only be used with keyboard emulation.

### Discard Data

- B8 Discards types of data. For example, you may want to discard Code 128 bar codes that begin with the letter A. In step 4 (page 6-2), select 6A (for Code 128), and in step 5, select 9999 (for all lengths). Enter FE41B8 to compare and discard Code 128 bar codes that begin with the letter A. Syntax = B8.

*Note: The B8 command must be entered after all other commands. The Data Format must be **Required** (see page 6-10) in order for the B8 command to work. If Data Format is On, but Not Required (page 6-10), bar code data that meets the B8 format is scanned and output as usual. Other data format settings impact the B8 command. If Data Format Non-Match Error Tone is **On** (page 6-11), the scanner emits an error tone. If Data format Non-Match Error Tone is **Off**, the code is disabled for reading and no tone is sounded.*

## Data Formatter

When Data Formatter is turned Off, the bar code data is output to the host as read, including prefixes and suffixes.



DFM\_END.

Data Formatter Off

You may wish to require the data to conform to a data format you have created and saved. The following settings can be applied to your data format:

### Data Formatter On, Not Required, Keep Prefix/Suffix

Scanned data is modified according to your data format, and prefixes and suffixes are transmitted.

### Data Formatter On, Not Required, Drop Prefix/Suffix

Scanned data is modified according to your data format. If a data format is found for a particular symbol, those prefixes and suffixes are not transmitted. If a data format is *not* found for that symbol, the prefixes and suffixes *are* transmitted.

---

### Data Format Required, Keep Prefix/Suffix

Scanned data is modified according to your data format, and prefixes and suffixes are transmitted. Any data that does not match your data format requirements generates an error tone and the data in that bar code is not transmitted. If you wish to process this type of bar code without generating an error tone, see [Data Format Non-Match Error Tone](#).

### Data Format Required, Drop Prefix/Suffix

Scanned data is modified according to your data format. If a data format is found for a particular symbol, those prefixes and suffixes are not transmitted. Any data that does not match your data format requirements generates an error tone. If you wish to process this type of bar code without generating an error tone, see [Data Format Non-Match Error Tone](#).

Choose one of the following options. *Default = Data Formatter On, Not Required, Keep Prefix/Suffix.*



DFM\_EN3.

**Data Formatter On,  
Not Required,  
Drop Prefix/Suffix**



DFM\_EN4.

**Data Format Required,  
Drop Prefix/Suffix**



DFM\_EN1.

**\* Data Formatter On,  
Not Required,  
Keep Prefix/Suffix**



DFM\_EN2.

**Data Format Required,  
Keep Prefix/Suffix**

### Data Format Non-Match Error Tone

When a bar code is encountered that doesn't match your required data format, the scanner normally generates an error tone. However, you may want to continue scanning bar codes without hearing the error tone. If you scan the **Data Format Non-Match Error Tone Off** bar code, data that doesn't conform to your data format is not transmitted, and no error tone



---

will sound. If you wish to hear the error tone when a non-matching bar code is found, scan the **Data Format Non-Match Error Tone On** bar code. *Default = Data Format Non-Match Error Tone On.*



DFMDEC1.

**Data Format Non-Match  
Error Tone Off**



DFMDEC0.

**\* Data Format Non-Match Error  
Tone On**

## ***Primary/Alternate Data Formats***

You can save up to four data formats, and switch between these formats. Your primary data format is saved under **0**. Your other three formats are saved under **1**, **2**, and **3**. To set your device to use one of these formats, scan one of the bar codes below.



ALTFNM0.

**Primary Data Format**



ALTFNM1.

**Data Format 1**



ALTFNM2.

**Data Format 2**



ALTFNM3.

**Data Format 3**

## ***Single Scan Data Format Change***

You can also switch between data formats for a single scan. The next bar code is scanned using an alternate data format, then reverts to the format you have selected above (either Primary, 1, 2, or 3).

---

For example, you may have set your device to the data format you saved as Data Format 3. You can switch to Data Format 1 for a single trigger pull by scanning the **Single Scan-Data Format 1** bar code below. The next bar code that is scanned uses Data Format 1, then reverts back to Data Format 3.



VSAF\_1.

**Single Scan-Data Format 1**



VSAF\_3.

**Single Scan-Data Format 3**



VSAF\_0.

**Single Scan-Primary  
Data Format**



VSAF\_2.

**Single Scan-Data Format 2**

# Symbologies

This programming section contains the following menu selections. Refer to [Chapter 11](#) for settings and defaults.

- All Symbologies
- Aztec Code
- China Post (Hong Kong 2 of 5)
- Chinese Sensible (Han Xin) Code
- Codabar
- Codablock A
- Codablock F
- Code 11
- Code 128
- Code 32 Pharmaceutical (PARAF)
- Code 39
- Code 93
- Data Matrix
- EAN/JAN-13
- EAN/JAN-8
- GS1 Composite Codes
- GS1 DataBar Expanded
- GS1 DataBar Limited
- GS1 DataBar Omnidirectional
- GS1 Emulation
- GS1-128
- Interleaved 2 of 5
- Korea Post
- Matrix 2 of 5
- MaxiCode
- MicroPDF417
- MSI
- NEC 2 of 5
- Postal Codes - 2D
- Postal Codes - Linear
- PDF417
- GS1 DataBar Omnidirectional
- QR Code
- Straight 2 of 5 IATA (two-bar start/stop)
- Straight 2 of 5 Industrial (three-bar start/stop)
- TCIF Linked Code 39 (TLC39)
- Telepen
- Trioptic Code
- UPC-A
- UPC-A/EAN-13 with Extended Coupon Code
- UPC-E0
- UPC-E1

---

## All Symbologies

If you want to decode all the symbologies allowable for your scanner, scan the **All Symbologies On** code. If on the other hand, you want to decode only a particular symbology, scan **All Symbologies Off** followed by the On symbol for that particular symbology.



ALLEN#1.

All Symbologies On



ALLEN#0.

All Symbologies Off

*Note: When All Symbologies On is scanned, 2D Postal Codes are not enabled. 2D Postal Codes must be enabled separately.*

## Message Length Description

You are able to set the valid reading length of some of the bar code symbologies. If the data length of the scanned bar code doesn't match the valid reading length, the scanner will issue an error tone. You may wish to set the same value for minimum and maximum length to force the scanner to read fixed length bar code data. This helps reduce the chances of a misread.

**EXAMPLE:** Decode only those bar codes with a count of 9-20 characters.  
Min. length = 09Max. length = 20

**EXAMPLE:** Decode only those bar codes with a count of 15 characters.  
Min. length = 15Max. length = 15

For a value other than the minimum and maximum message length defaults, scan the bar codes included in the explanation of the symbology, then scan the digit value of the message length and **Save** bar codes on the [Programming Chart](#) inside the back cover of this manual. The minimum and maximum lengths and the defaults are included with the respective symbologies.

---

## Codabar

<Default All Codabar Settings>



### Codabar On/Off



### Codabar Start/Stop Characters

Start/Stop characters identify the leading and trailing ends of the bar code. You may either transmit, or not transmit Start/Stop characters. *Default = Don't Transmit.*



### Codabar Check Character

Codabar check characters are created using different “modulos.” You can program the scanner to read only Codabar bar codes with Modulo 16 check characters. *Default = No Check Character.*

**No Check Character** indicates that the scanner reads and transmits bar code data with or without a check character.

When Check Character is set to **Validate and Transmit**, the scanner will only read Codabar bar codes printed with a check character, and will transmit this character at the end of the scanned data.

---

When Check Character is set to **Validate, but Don't Transmit**, the unit will only read Codabar bar codes printed **with** a check character, but will not transmit the check character with the scanned data.



CBRCK20.

\* No Check Character



CBRCK21.

Validate Modulo 16, but  
Don't Transmit



CBRCK22.

Validate Modulo 16  
and Transmit

### **Codabar Concatenation**

Codabar supports symbol concatenation. When you enable concatenation, the scanner looks for a Codabar symbol having a “D” start character, adjacent to a symbol having a “D” stop character. In this case the two messages are concatenated into one with the “D” characters omitted.



A 1 2 3 4 D D 5 6 7 8 A

Select Require to prevent the scanner from decoding a single “D” Codabar symbol without its companion. This selection has no effect on Codabar symbols without Stop/Start D characters.



CBRCC1.

On



CBRCC0.

\* Off



CBRCC2.

Require

---

## ***Codabar Message Length***

Scan the bar codes below to change the message length. Refer to [Message Length Description](#) (page 7-2) for additional information. Minimum and Maximum lengths = 2-60. Minimum Default = 4, Maximum Default = 60.



CBRMIN.

**Minimum Message Length**



CBRMAX.

**Maximum Message Length**

---

## Code 39

< Default All Code 39 Settings >



### Code 39 On/Off



### Code 39 Start/Stop Characters

Start/Stop characters identify the leading and trailing ends of the bar code. You may either transmit, or not transmit Start/Stop characters. *Default = Don't Transmit.*



### Code 39 Check Character

**No Check Character** indicates that the scanner reads and transmits bar code data with or without a check character.

When Check Character is set to **Validate, but Don't Transmit**, the unit only reads Code 39 bar codes printed with a check character, but will not transmit the check character with the scanned data.



---

When Check Character is set to **Validate and Transmit**, the scanner only reads Code 39 bar codes printed with a check character, and will transmit this character at the end of the scanned data. *Default = No Check Character.*



C39CK20.

\* No Check Character



C39CK21.

Validate, but Don't Transmit



C39CK22.

Validate and Transmit

### Code 39 Message Length

Scan the bar codes below to change the message length. Refer to [Message Length Description](#) (page 7-2) for additional information. Minimum and Maximum lengths = 0-48. Minimum Default = 0, Maximum Default = 48.



C39MIN.

Minimum Message Length



C39MAX.

Maximum Message Length

### Code 39 Append

This function allows the scanner to append the data from several Code 39 bar codes together before transmitting them to the host computer. When the scanner encounters a Code 39 bar code with the append trigger char-

---

acter(s), it buffers Code 39 bar codes until it reads a Code 39 bar code that does not have the append trigger. The data is then transmitted in the order in which the bar codes were read (FIFO). *Default = Off.*



C39APP1.  
On



C39APP0.  
\* Off

### **Code 32 Pharmaceutical (PARAF)**

Code 32 Pharmaceutical is a form of the Code 39 symbology used by Italian pharmacies. This symbology is also known as PARAF.

*Note: Trioptic Code ([page 7-40](#)) must be turned off while scanning Code 32 Pharmaceutical codes.*



C39B321.  
On



C39B320.  
\* Off

## Full ASCII

If Full ASCII Code 39 decoding is enabled, certain character pairs within the bar code symbol will be interpreted as a single character. For example: \$V will be decoded as the ASCII character SYN, and /C will be decoded as the ASCII character #. *Default = Off.*

NUL %U	DLE \$P	SP SPACE	0 0	@ %V	P P	' %W	p +P
SOH \$A	DC1 \$Q	! /A	1 1	A A	Q Q	a +A	q +Q
STX \$B	DC2 \$R	" /B	2 2	B B	R R	b +B	r +R
ETX \$C	DC3 \$S	# /C	3 3	C C	S S	c +C	s +S
EOT \$D	DC4 \$T	\$ /D	4 4	D D	T T	d +D	t +T
ENQ \$E	NAK \$U	% /E	5 5	E E	U U	e +E	u +U
ACK \$F	SYN \$V	& /F	6 6	F F	V V	f +F	v +V
BEL \$G	ETB \$W	' /G	7 7	G G	W W	g +G	w +W
BS \$H	CAN \$X	( /H	8 8	H H	X X	h +H	x +X
HT \$I	EM \$Y	) /I	9 9	I I	Y Y	i +I	y +Y
LF \$J	SUB \$Z	* /J	: /Z	J J	Z Z	j +J	z +Z
VT \$K	ESC %A	+ /K	; %F	K K	[ %K	k +K	{ %P
FF \$L	FS %B	, /L	< %G	L L	\ %L	l +L	%Q
CR \$M	GS %C	- -	= %H	M M	] %M	m +M	} %R
SO \$N	RS %D	. .	> %I	N N	^ %N	n +N	~ %S
SI \$O	US %E	/ /O	? %J	O O	_ %O	o +O	DEL %T

Character pairs /M and /N decode as a minus sign and period respectively. Character pairs /P through /Y decode as 0 through 9.



C39ASCII.  
Full ASCII On



C39ASCII.  
\* Full ASCII Off

## Code 39 Code Page

Code pages define the mapping of character codes to characters. If the data received does not display with the proper characters, it may be because the bar code being scanned was created using a code page that is different from the one the host program is expecting. If this is the case, scan the bar code below, select the code page with which the bar codes were created (see [Code Page Mapping of Printed Bar Codes](#) on page A-6),

---

and scan the value and the **Save** bar code from the [Programming Chart](#) on the inside the back cover of this manual. The data characters should then appear properly.



C39DCP.  
Code 39 Code Page

## ***Interleaved 2 of 5***

*< Default All Interleaved 2 of 5 Settings >*



I25DFT.

## ***Interleaved 2 of 5 On/Off***



I25ENA1.

\* On



I25ENA0.

Off

## ***Check Digit***

**No Check Digit** indicates that the scanner reads and transmits bar code data with or without a check digit.

When Check Digit is set to **Validate, but Don't Transmit**, the unit only reads Interleaved 2 of 5 bar codes printed with a check digit, but will not transmit the check digit with the scanned data.

---

When Check Digit is set to **Validate and Transmit**, the scanner only reads Interleaved 2 of 5 bar codes printed with a check digit, and will transmit this digit at the end of the scanned data. *Default = No Check Digit.*



I25CK20.

**\* No Check Digit**



I25CK21.

**Validate, but Don't Transmit**



I25CK22.

**Validate and Transmit**

### ***Interleaved 2 of 5 Message Length***

Scan the bar codes below to change the message length. Refer to [Message Length Description](#) (page 7-2) for additional information. Minimum and Maximum lengths = 2-80. Minimum Default = 4, Maximum Default = 80.



I25MIN.

**Minimum Message Length**



I25MAX.

**Maximum Message Length**

---

## NEC 2 of 5

< Default All NEC 2 of 5 Settings >



N25DFT.

### NEC 2 of 5 On/Off



N25ENA1.

\* On



N25ENA0.

Off

### Check Digit

**No Check Digit** indicates that the scanner reads and transmits bar code data with or without a check digit.

When Check Digit is set to **Validate, but Don't Transmit**, the unit only reads NEC 2 of 5 bar codes printed with a check digit, but will not transmit the check digit with the scanned data.

When Check Digit is set to **Validate and Transmit**, the scanner only reads NEC 2 of 5 bar codes printed with a check digit, and will transmit this digit at the end of the scanned data. *Default = No Check Digit.*



N25CK20.

\* No Check Digit



N25CK21.

Validate, but Don't Transmit



N25CK22.

Validate and Transmit

---

## ***NEC 2 of 5 Message Length***

Scan the bar codes below to change the message length. Refer to [Message Length Description](#) (page 7-2) for additional information. Minimum and Maximum lengths = 2-80. Minimum Default = 4, Maximum Default = 80.



N25MIN.

**Minimum Message Length**



N25MAX.

**Maximum Message Length**

---

## Code 93

< Default All Code 93 Settings >



C93DFT.

### Code 93 On/Off



C93ENA1.

\* On



C93ENAO.

Off

### Code 93 Message Length

Scan the bar codes below to change the message length. Refer to [Message Length Description](#) (page 7-2) for additional information. Minimum and Maximum lengths = 0-80. Minimum Default = 0, Maximum Default = 80.



C93MIN.

Minimum Message Length



C93MAX.

Maximum Message Length

### Code 93 Append

This function allows the scanner to append the data from several Code 93 bar codes together before transmitting them to the host computer. When this function is enabled, the scanner stores those Code 93 bar codes that start with a space (excluding the start and stop symbols), and does not immediately transmit the data. The scanner stores the data in the order in



---

which the bar codes are read, deleting the first space from each. The scanner transmits the appended data when it reads a Code 93 bar code that starts with a character other than a space. *Default = Off.*



C93APP1.

**On**



C93APP0.

**\* Off**

### ***Code 93 Code Page***

Code pages define the mapping of character codes to characters. If the data received does not display with the proper characters, it may be because the bar code being scanned was created using a code page that is different from the one the host program is expecting. If this is the case, scan the bar code below, select the code page with which the bar codes were created (see [Code Page Mapping of Printed Bar Codes](#) on page A-6), and scan the value and the **Save** bar code from the [Programming Chart](#) on the inside the back cover of this manual. The data characters should then appear properly.



C93DCP.

**Code 93 Code Page**

---

## **Straight 2 of 5 Industrial (three-bar start/stop)**

<Default All Straight 2 of 5 Industrial Settings>



R25DFT.

### **Straight 2 of 5 Industrial On/Off**



R25ENA1.

**On**



R25ENA0.

**\* Off**

### **Straight 2 of 5 Industrial Message Length**

Scan the bar codes below to change the message length. Refer to [Message Length Description](#) (page 7-2) for additional information. Minimum and Maximum lengths = 1-48. Minimum Default = 4, Maximum Default = 48.



R25MIN.

**Minimum Message Length**



R25MAX.

**Maximum Message Length**

---

## ***Straight 2 of 5 IATA (two-bar start/stop)***

*<Default All Straight 2 of 5 IATA Settings>*



### ***Straight 2 of 5 IATA On/Off***



### ***Straight 2 of 5 IATA Message Length***

Scan the bar codes below to change the message length. Refer to [Message Length Description](#) (page 7-2) for additional information. Minimum and Maximum lengths = 1-48. Minimum Default = 4, Maximum Default = 48.



---

## Matrix 2 of 5

<Default All Matrix 2 of 5 Settings>



X25DFT.

### Matrix 2 of 5 On/Off



X25ENA1.

On



X25ENA0.

\* Off

### Matrix 2 of 5 Message Length

Scan the bar codes below to change the message length. Refer to [Message Length Description](#) (page 7-2) for additional information. Minimum and Maximum lengths = 1-80. Minimum Default = 4, Maximum Default = 80.



X25MIN.

Minimum Message Length



X25MAX.

Maximum Message Length

---

## Code 11

<Default All Code 11 Settings>



C11DFT.

### Code 11 On/Off



C11ENA1.

On



C11ENAD.

\* Off

### Check Digits Required

This option sets whether 1 or 2 check digits are required with Code 11 bar codes. *Default = Two Check Digits.*



C11CK20.

One Check Digit



C11CK21.

\* Two Check Digits

---

## **Code 11 Message Length**

Scan the bar codes below to change the message length. Refer to [Message Length Description](#) (page 7-2) for additional information. Minimum and Maximum lengths = 1-80. Minimum Default = 4, Maximum Default = 80.



C11MIN.

**Minimum Message Length**



C11MAX.

**Maximum Message Length**

## **Code 128**

*<Default All Code 128 Settings>*



128DFT.

## **Code 128 On/Off**



128ENA1.

\* On



128ENA0.

Off

## **ISBT 128 Concatenation**

In 1994 the International Society of Blood Transfusion (ISBT) ratified a standard for communicating critical blood information in a uniform manner. The use of ISBT formats requires a paid license. The ISBT 128 Application Specification describes 1) the critical data elements for labeling blood products, 2) the current recommendation to use Code 128 due to its high degree of security and its space-efficient design, 3) a variation of Code 128

---

that supports concatenation of neighboring symbols, and 4) the standard layout for bar codes on a blood product label. Use the bar codes below to turn concatenation on or off. *Default =Off.*



ISBENA1.

**On**



ISBENA0.

**\* Off**

### **Code 128 Message Length**

Scan the bar codes below to change the message length. Refer to [Message Length Description](#) (page 7-2) for additional information. Minimum and Maximum lengths = 0-80. Minimum Default = 0, Maximum Default = 80.



128MIN.

**Minimum Message Length**



128MAX.

**Maximum Message Length**

### **Code 128 Append**

This function allows the scanner to append the data from several Code 128 bar codes together before transmitting them to the host computer. When the scanner encounters a Code 128 bar code with the append trigger character(s), it buffers Code 128 bar codes until it reads a Code 128 bar code that does not have the append trigger. The data is then transmitted in the order in which the bar codes were read (FIFO). *Default = Off.*



128APP1.

**On**



128APP0.

**\* Off**

---

## ***Code 128 Code Page***

Code pages define the mapping of character codes to characters. If the data received does not display with the proper characters, it may be because the bar code being scanned was created using a code page that is different from the one the host program is expecting. If this is the case, scan the bar code below, select the code page with which the bar codes were created (see [Code Page Mapping of Printed Bar Codes](#) on page A-6), and scan the value and the **Save** bar code from the [Programming Chart](#) on the inside the back cover of this manual. The data characters should then appear properly.



128DCP.

**Code 128 Code Page**



---

## GS1-128

<Default All GS1-128 Settings>



GS1DFT.

### GS1-128 On/Off



GS1ENA1.

\* On



GS1ENA0.

Off

### GS1-128 Message Length

Scan the bar codes below to change the message length. Refer to [Message Length Description](#) (page 7-2) for additional information. Minimum and Maximum lengths = 1-80. Minimum Default = 1, Maximum Default = 80.



GS1MIN.

Minimum Message Length



GS1MAX.

Maximum Message Length

---

## Telepen

<Default All Telepen Settings>



### Telepen On/Off



### Telepen Output

Using AIM Telepen Output, the scanner reads symbols with start/stop pattern 1 and decodes them as standard full ASCII (start/stop pattern 1). When Original Telepen Output is selected, the scanner reads symbols with start/stop pattern 1 and decodes them as compressed numeric with optional full ASCII (start/stop pattern 2). *Default = AIM Telepen Output.*



---

## Telepen Message Length

Scan the bar codes below to change the message length. Refer to [Message Length Description](#) (page 7-2) for additional information. Minimum and Maximum lengths = 1-60. Minimum Default = 1, Maximum Default = 60.



TELMIN.

Minimum Message Length



TELMAX.

Maximum Message Length

## UPC-A

<Default All UPC-A Settings>



UPADFT.

### UPC-A On/Off



UPAENA1.

\* On



UPAENA0.

Off

### UPC-A Check Digit

This selection allows you to specify whether the check digit should be transmitted at the end of the scanned data or not. *Default = On.*



UPACKX1.

\* On



UPACKX0.

Off

---

## UPC-A Number System

The numeric system digit of a U.P.C. symbol is normally transmitted at the beginning of the scanned data, but the unit can be programmed so it will not transmit it. *Default = On.*



## UPC-A Addenda

This selection adds 2 or 5 digits to the end of all scanned UPC-A data. *Default = Off for both 2 Digit and 5 Digit Addenda.*



## UPC-A Addenda Required

When **Required** is scanned, the scanner will only read UPC-A bar codes that have addenda. You must then turn on a 2 or 5 digit addenda listed on [page 7-26](#). *Default = Not Required.*



---

## UPC-A Addenda Separator

When this feature is on, there is a space between the data from the bar code and the data from the addenda. When turned off, there is no space.  
*Default = On.*



UPAADS1.

\* On



UPAADS0.

Off

## UPC-A/EAN-13 with Extended Coupon Code

Use the following codes to enable or disable UPC-A and EAN-13 with Extended Coupon Code. When left on the default setting (**Off**), the scanner treats Coupon Codes and Extended Coupon Codes as single bar codes.

If you scan the **Allow Concatenation** code, when the scanner sees the coupon code and the extended coupon code in a single scan, it transmits both as separate symbologies. Otherwise, it transmits the first coupon code it reads.

If you scan the **Require Concatenation** code, the scanner must see and read the coupon code and extended coupon code in a single read to transmit the data. No data is output unless both codes are read.

*Default = Off.*



CPNENA0.

\* Off



CPNENA1.

Allow Concatenation



CPNENA2.

Require Concatenation

---

## Coupon GS1 DataBar Output

If you scan coupons that have both UPC and GS1 DataBar codes, you may wish to scan and output only the data from the GS1 DataBar code. Scan the **GS1 Output On** code below to scan and output only the GS1 DataBar code data. *Default = GS1 Output Off.*



CPNGS10.  
\* **GS1 Output Off**



CPNGS11.  
**GS1 Output On**

## UPC-E0

<Default All UPC-E Settings>



UPEDFT.

## UPC-E0 On/Off

Most U.P.C. bar codes lead with the 0 number system. To read these codes, use the **UPC-E0 On** selection. If you need to read codes that lead with the 1 number system, use [UPC-E1](#) (page 7-31). *Default = On.*



UPEEND01.  
\* **UPC-E0 On**



UPEEND00.  
**UPC-E0 Off**

---

## UPC-E0 Expand

UPC-E Expand expands the UPC-E code to the 12 digit, UPC-A format.  
*Default = Off.*



UPEEXP1.

**On**



UPEEXP0.

**\* Off**

## UPC-E0 Addenda Required

When **Required** is scanned, the scanner will only read UPC-E bar codes that have addenda. *Default = Not Required.*



UPEARQ1.

**Required**



UPEARQ0.

**\* Not Required**

## UPC-E0 Addenda Separator

When this feature is **On**, there is a space between the data from the bar code and the data from the addenda. When turned **Off**, there is no space.  
*Default = On.*



UPEADS1.

**\* On**



UPEADS0.

**Off**

---

## UPC-E0 Check Digit

Check Digit specifies whether the check digit should be transmitted at the end of the scanned data or not. *Default = On.*



UPECKX1.

\* On



UPECKXD.

Off

## UPC-E0 Number System

The numeric system digit of a U.P.C. symbol is normally transmitted at the beginning of the scanned data, but the unit can be programmed so it will not transmit it. To prevent transmission, scan **Off**. *Default = On.*



UPENSX1.

\* On



UPENSXD.

Off

## UPC-E0 Addenda

This selection adds 2 or 5 digits to the end of all scanned UPC-E data. *Default = Off for both 2 Digit and 5 Digit Addenda.*



UPEAD21.

2 Digit Addenda On



UPEAD20.

\* 2 Digit Addenda Off



UPEAD51.

5 Digit Addenda On



UPEAD50.

\* 5 Digit Addenda Off



---

## UPC-E1

Most U.P.C. bar codes lead with the 0 number system. For these codes, use **UPC-E0** (page 7-28). If you need to read codes that lead with the 1 number system, use the **UPC-E1 On** selection. *Default = Off.*



UPEEN11.  
UPC-E1 On



UPEEN10.  
\* UPC-E1 Off

## EAN/JAN-13

<Default All EAN/JAN Settings>



E13DFT.

### EAN/JAN-13 On/Off



E13ENA1.  
\* On



E13ENAD.  
Off

### EAN/JAN-13 Check Digit

This selection allows you to specify whether the check digit should be transmitted at the end of the scanned data or not. *Default = On.*



E13CKX1.  
\* On



E13CKXD.  
Off

---

## ***EAN/JAN-13 Addenda***

This selection adds 2 or 5 digits to the end of all scanned EAN/JAN-13 data. *Default = Off for both 2 Digit and 5 Digit Addenda.*



E13AD21.  
**2 Digit Addenda On**



E13AD20.  
**\* 2 Digit Addenda Off**



E13AD51.  
**5 Digit Addenda On**



E13AD50.  
**\* 5 Digit Addenda Off**

## ***EAN/JAN-13 Addenda Required***

When **Required** is scanned, the scanner will only read EAN/JAN-13 bar codes that have addenda. *Default = Not Required.*



E13ARQ1.  
**Required**



E13ARQ0.  
**\* Not Required**

---

## ***EAN/JAN-13 Addenda Separator***

When this feature is **On**, there is a space between the data from the bar code and the data from the addenda. When turned **Off**, there is no space. *Default = On.*



E13ADS1.

\* **On**



E13ADS0.

**Off**

*Note: If you want to enable or disable EAN13 with Extended Coupon Code, refer to [UPC-A/EAN-13 with Extended Coupon Code](#) (page 7-27).*

## ***ISBN Translate***

When **On** is scanned, EAN-13 Bookland symbols are translated into their equivalent ISBN number format. *Default = Off.*



E13ISB1.

**On**



E13ISB0.

\* **Off**

---

# EAN/JAN-8

<Default All EAN/JAN-8 Settings>



EA8DFT.

## EAN/JAN-8 On/Off



EA8ENA1.

\* On



EA8ENAD.

Off

## EAN/JAN-8 Check Digit

This selection allows you to specify whether the check digit should be transmitted at the end of the scanned data or not. *Default = On.*



EA8CKX1.

\* On



EA8CKXD.

Off

---

## ***EAN/JAN-8 Addenda***

This selection adds 2 or 5 digits to the end of all scanned EAN/JAN-8 data.  
*Default = Off for both 2 Digit Addenda and 5 Digit Addenda.*



EABAD21.  
**2 Digit Addenda On**



EABAD20.  
**\* 2 Digit Addenda Off**



EABAD51.  
**5 Digit Addenda On**



EABAD50.  
**\* 5 Digit Addenda Off**

## ***EAN/JAN-8 Addenda Required***

When **Required** is scanned, the scanner will only read EAN/JAN-8 bar codes that have addenda. *Default = Not Required.*



EABARQ1.  
**Required**



EABARQ0.  
**\* Not Required**

## ***EAN/JAN-8 Addenda Separator***

When this feature is **On**, there is a space between the data from the bar code and the data from the addenda. When turned **Off**, there is no space.  
*Default = On.*



EABADS1.  
**\* On**



EABADS0.  
**Off**

---

# MSI

<Default All MSI Settings>



## MSI On/Off



## MSI Check Character

Different types of check characters are used with MSI bar codes. You can program the scanner to read MSI bar codes with Type 10 check characters. *Default = Validate Type 10, but Don't Transmit.*

When Check Character is set to **Validate Type 10/11 and Transmit**, the scanner will only read MSI bar codes printed with the specified type check character(s), and will transmit the character(s) at the end of the scanned data.

---

When Check Character is set to **Validate Type 10/11, but Don't Transmit**, the unit will only read MSI bar codes printed with the specified type check character(s), but will not transmit the check character(s) with the scanned data.



MSICHK0.

\* **Validate Type 10, but Don't Transmit**



MSICHK2.

**Validate 2 Type 10 Characters, but Don't Transmit**



MSICHK4.

**Validate Type 10 then Type 11 Character, but Don't Transmit**



MSICHK6.

**Disable MSI Check Characters**



MSICHK1.

**Validate Type 10 and Transmit**



MSICHK3.

**Validate 2 Type 10 Characters and Transmit**



MSICHK5.

**Validate Type 10 then Type 11 Character and Transmit**

## ***MSI Message Length***

Scan the bar codes below to change the message length. Refer to [Message Length Description](#) (page 7-2) for additional information. Minimum and Maximum lengths = 4-48. Minimum Default = 4, Maximum Default = 48.



MSIMIN.

**Minimum Message Length**



MSIMAX.

**Maximum Message Length**

---

## **GS1 DataBar Omnidirectional**

*< Default All GS1 DataBar Omnidirectional Settings >*



RSSDFT.

### **GS1 DataBar Omnidirectional On/Off**



RSSENA1.

\* On



RSSENA0.

Off

## **GS1 DataBar Limited**

*< Default All GS1 DataBar Limited Settings >*



RSLDFT.

### **GS1 DataBar Limited On/Off**



RSLENA1.

\* On



RSLENA0.

Off



---

## **GS1 DataBar Expanded**

< Default All GS1 DataBar Expanded Settings >



### **GS1 DataBar Expanded On/Off**



### **GS1 DataBar Expanded Message Length**

Scan the bar codes below to change the message length. Refer to [Message Length Description](#) (page 7-2) for additional information. Minimum and Maximum lengths = 4-74. Minimum Default = 4, Maximum Default = 74.



---

## ***Trioptic Code***

*Note: If you are going to scan Code 32 Pharmaceutical codes (page 7-8), Trioptic Code must be off.*

Trioptic Code is used for labeling magnetic storage media.



TRIENA1.

**On**



TRIENA0.

**\* Off**

## ***Codablock A***

*<Default All Codablock A Settings>*



CBADFT.

## ***Codablock A On/Off***



CBAENA1.

**On**



CBAENA0.

**\* Off**

---

## ***Codablock A Message Length***

Scan the bar codes below to change the message length. Refer to [Message Length Description](#) (page 7-2) for additional information. Minimum and Maximum lengths = 1-600. Minimum Default = 1, Maximum Default = 600.



CBAMIN.

**Minimum Message Length**



CBAMAX.

**Maximum Message Length**

---

## Codablock F

<Default All Codablock F Settings>



### Codablock F On/Off



### Codablock F Message Length

Scan the bar codes below to change the message length. Refer to [Message Length Description](#) (page 7-2) for additional information. Minimum and Maximum lengths = 1-2048. Minimum Default = 1, Maximum Default = 2048.



---

## PDF417

< Default All PDF417 Settings >



PDFDFT.

### PDF417 On/Off



PDFENA1.  
\* On



PDFENA0.  
Off

### PDF417 Message Length

Scan the bar codes below to change the message length. Refer to [Message Length Description](#) (page 7-2) for additional information. Minimum and Maximum lengths = 1-2750. Minimum Default = 1, Maximum Default = 2750.



PDFMIN.  
Minimum Message Length



PDFMAX.  
Maximum Message Length

---

## **MacroPDF417**

MacroPDF417 is an implementation of PDF417 capable of encoding very large amounts of data into multiple PDF417 bar codes. When this selection is enabled, these multiple bar codes are assembled into a single data string.  
*Default = On.*



PDFMAC1.  
**\* On**



PDFMAC0.  
**Off**

## **MicroPDF417**

*< Default All MicroPDF417 Settings >*



MPDDFT.

## **MicroPDF417 On/Off**



MPDENA1.  
**On**



MPDENA0.  
**\* Off**

---

## MicroPDF417 Message Length

Scan the bar codes below to change the message length. Refer to [Message Length Description](#) (page 7-2) for additional information. Minimum and Maximum lengths = 1-366. Minimum Default = 1, Maximum Default = 366.



MPDMIN.

Minimum Message Length



MPDMAX.

Maximum Message Length

## GS1 Composite Codes

Linear codes are combined with a unique 2D composite component to form a new class called GS1 Composite symbology. GS1 Composite symbologies allow for the co-existence of symbologies already in use. *Default = Off.*



COMENA1.

On



COMENAO.

\* Off

## UPC/EAN Version

Scan the **UPC/EAN Version On** bar code to decode GS1 Composite symbols that have a U.P.C. or an EAN linear component. (This does not affect GS1 Composite symbols with a GS1-128 or GS1 linear component.) *Default = UPC/EAN Version Off.*



COMUPC1.

UPC/EAN Version On



COMUPCO.

\* UPC/EAN Version Off

*Note: If you scan coupons that have both UPC and GS1 DataBar codes, you may wish to scan and output only the data from the GS1 DataBar code. See [Coupon GS1 DataBar Output](#) (page 7-28) for further information.*

---

## GS1 Composite Code Message Length

Scan the bar codes below to change the message length. Refer to [Message Length Description](#) (page 7-2) for additional information. Minimum and Maximum lengths = 1-2435. Minimum Default = 1, Maximum Default = 2435.



COMMIN.

Minimum Message Length



COMMAX.

Maximum Message Length

## GS1 Emulation

The scanner can automatically format the output from any GS1 data carrier to emulate what would be encoded in an equivalent GS1-128 or GS1 DataBar symbol. GS1 data carriers include UPC-A and UPC-E, EAN-13 and EAN-8, ITF-14, GS1-128, and GS1-128 DataBar and GS1 Composites. (Any application that accepts GS1 data can be simplified since it only needs to recognize one data carrier type.)

If **GS1-128 Emulation** is scanned, all retail codes (U.P.C., UPC-E, EAN8, EAN13) are expanded out to 16 digits. If the AIM ID is enabled, the value will be the GS1-128 AIM ID, ]C1 (see [Symbology Chart](#) on page A-1).

If **GS1 DataBar Emulation** is scanned, all retail codes (U.P.C., UPC-E, EAN8, EAN13) are expanded out to 16 digits. If the AIM ID is enabled, the value will be the GS1-DataBar AIM ID, ]em (see [Symbology Chart](#) on page A-1).

If **GS1 Code Expansion Off** is scanned, retail code expansion is disabled, and UPC-E expansion is controlled by the [UPC-E0 Expand](#) (page 7-29) setting. If the AIM ID is enabled, the value will be the GS1-128 AIM ID, ]C1 (see [Symbology Chart](#) on page A-1).

If **EAN8 to EAN13 Conversion** is scanned, all EAN8 bar codes are converted to EAN13 format.



---

*Default = GS1 Emulation Off.*



EANEMU1.  
**GS1-128 Emulation**



EANEMU3.  
**GS1 Code Expansion Off**



EANEMU0.  
**\* GS1 Emulation Off**



EANEMU2.  
**GS1 DataBar Emulation**



EANEMU4.  
**EAN8 to EAN13 Conversion**

## ***TCIF Linked Code 39 (TLC39)***

This code is a composite code since it has a Code 39 linear component and a MicroPDF417 stacked code component. All bar code readers are capable of reading the Code 39 linear component. The MicroPDF417 component can only be decoded if **TLC39 On** is selected. The linear component may be decoded as Code 39 even if TLC39 is off. *Default = Off.*



T39ENA1.  
**On**



T39ENA0.  
**\* Off**

---

## QR Code

< Default All QR Code Settings >



### QR Code On/Off

This selection applies to both QR Code and Micro QR Code.



### QR Code Message Length

Scan the bar codes below to change the message length. Refer to [Message Length Description](#) (page 7-2) for additional information. Minimum and Maximum lengths = 1-7089. Minimum Default = 1, Maximum Default = 7089.



### QR Code Append

This function allows the scanner to append the data from several QR Code bar codes together before transmitting them to the host computer. When the scanner encounters an QR Code bar code with the append trigger character(s), it buffers the number of QR Code bar codes determined by

---

information encoded in those bar codes. Once the proper number of codes is reached, the data is output in the order specified in the bar codes.  
*Default = On.*



QRCAPP1.  
\* On



QRCAPP0.  
Off

### ***QR Code Page***

QR Code pages define the mapping of character codes to characters. If the data received does not display with the proper characters, it may be because the bar code being scanned was created using a code page that is different from the one the host program is expecting. If this is the case, scan the bar code below, select the code page with which the bar codes were created (see [Code Page Mapping of Printed Bar Codes](#) on page A-6), and scan the value and the **Save** bar code from the [Programming Chart](#) on the inside the back cover of this manual. The data characters should then appear properly.



QRCDP.  
QR Code Page

---

## Data Matrix

< Default All Data Matrix Settings >



### Data Matrix On/Off



### Data Matrix Message Length

Scan the bar codes below to change the message length. Refer to [Message Length Description](#) (page 7-2) for additional information. Minimum and Maximum lengths = 1-3116. Minimum Default = 1, Maximum Default = 3116.



Minimum Message Length



Maximum Message Length

### Data Matrix Append

This function allows the scanner to append the data from several Data Matrix bar codes together before transmitting them to the host computer. When the scanner encounters an Data Matrix bar code with the append trigger character(s), it buffers the number of Data Matrix bar codes deter-

---

mined by information encoded in those bar codes. Once the proper number of codes is reached, the data is output in the order specified in the bar codes. *Default = On.*



IDMAPP1.  
\* **On**



IDMAPPO.  
**Off**

### ***Data Matrix Code Page***

Data Matrix Code pages define the mapping of character codes to characters. If the data received does not display with the proper characters, it may be because the bar code being scanned was created using a code page that is different from the one the host program is expecting. If this is the case, scan the bar code below, select the code page with which the bar codes were created (see [Code Page Mapping of Printed Bar Codes](#) on page A-6), and scan the value and the **Save** bar code from the [Programming Chart](#) on the inside the back cover of this manual. The data characters should then appear properly.



IDMDCP.  
**Data Matrix Code Page**

---

# MaxiCode

< Default All MaxiCode Settings >



## MaxiCode On/Off



## MaxiCode Message Length

Scan the bar codes below to change the message length. Refer to [Message Length Description](#) (page 7-2) for additional information. Minimum and Maximum lengths = 1-150. Minimum Default = 1, Maximum Default = 150.



---

## Aztec Code

< Default All Aztec Code Settings >



### Aztec Code On/Off



### Aztec Code Message Length

Scan the bar codes below to change the message length. Refer to [Message Length Description](#) (page 7-2) for additional information. Minimum and Maximum lengths = 1-3832. Minimum Default = 1, Maximum Default = 3832.



### Aztec Append

This function allows the scanner to append the data from several Aztec bar codes together before transmitting them to the host computer. When the scanner encounters an Aztec bar code with the append trigger charac-

---

ter(s), it buffers the number of Aztec bar codes determined by information encoded in those bar codes. Once the proper number of codes is reached, the data is output in the order specified in the bar codes. *Default = Off.*



AZTAPP1.  
On



AZTAPP0.  
\* Off

## ***Aztec Code Page***

Aztec Code pages define the mapping of character codes to characters. If the data received does not display with the proper characters, it may be because the bar code being scanned was created using a code page that is different from the one the host program is expecting. If this is the case, scan the bar code below, select the code page with which the bar codes were created (see [Code Page Mapping of Printed Bar Codes](#) on page A-6), and scan the value and the **Save** bar code from the [Programming Chart](#) on the inside the back cover of this manual. The data characters should then appear properly.



AZTDCP.  
**Aztec Code Page**



---

## Chinese Sensible (Han Xin) Code

< Default All Han Xin Settings >



HX\_DFT.

### Han Xin Code On/Off



HX\_ENA1.

On



HX\_ENA0.

\* Off

### Han Xin Code Message Length

Scan the bar codes below to change the message length. Refer to [Message Length Description](#) (page 7-2) for additional information. Minimum and Maximum lengths = 1-7833. Minimum Default = 1, Maximum Default = 7833.



HX\_MIN.

Minimum Message Length



HX\_MAX.

Maximum Message Length

---

## **Postal Codes - 2D**

The following lists the possible 2D postal codes, and 2D postal code combinations that are allowed. Only one 2D postal code selection can be active at a time. If you scan a second 2D postal code selection, the first selection is overwritten. *Default = 2D Postal Codes Off.*



POSTAL0.

**\* 2D Postal Codes Off**

### **Single 2D Postal Codes:**



POSTAL7.

**British Post On**



POSTAL10.

**Intelligent Mail Bar Code On**



POSTAL4.

**KIX Post On**



POSTAL9.

**Postal-4i On**



POSTAL1.

**Australian Post On**



POSTAL30.

**Canadian Post On**



POSTAL3.

**Japanese Post On**



POSTAL5.

**Planet Code On**

*Also see [Planet Code Check Digit](#), page 7-59.*



POSTAL6.

Postnet On

Also see *Postnet Check Digit*, page 7-59.



POSTAL11.

Postnet with B and B' Fields On



POSTAL2.

InfoMail On

### ***Combination 2D Postal Codes:***



POSTAL20.

Intelligent Mail Bar Code and Postnet with B and B' Fields On



POSTAL8.

InfoMail and British Post On



POSTAL16.

Postnet and Intelligent Mail Bar Code On



POSTAL14.

Postnet and Postal-4i On



POSTAL19.

Postal-4i and Postnet with B and B' Fields On



POSTAL17.

Postal-4i and Intelligent Mail Bar Code On



POSTAL18.

Planet Code and Postnet with B and B' Fields On



POSTAL12.

Planet Code and Postnet On



**POSTAL15.**  
Planet Code and  
Intelligent Mail Bar Code On



**POSTAL22.**  
Planet Code,  
Postnet, and  
Intelligent Mail Bar Code On



**POSTAL24.**  
Postnet,  
Postal-4i, and  
Intelligent Mail Bar Code On



**POSTAL26.**  
Planet Code,  
Intelligent Mail Bar Code, and  
Postnet with B and B' Fields On



**POSTAL28.**  
Planet Code,  
Postal-4i,  
Intelligent Mail Bar Code, and  
Postnet On



**POSTAL13.**  
Planet Code and  
Postal-4i On



**POSTAL21.**  
Planet Code,  
Postnet, and  
Postal-4i On



**POSTAL23.**  
Planet Code,  
Postal-4i, and  
Intelligent Mail Bar Code On



**POSTAL25.**  
Planet Code,  
Postal-4i, and  
Postnet with B and B' Fields On



**POSTAL27.**  
Postal-4i,  
Intelligent Mail Bar Code, and  
Postnet with B and B' Fields On



**POSTAL29.**  
Planet Code,  
Postal-4i,  
Intelligent Mail Bar Code, and  
Postnet with B and B' Fields On

---

## ***Planet Code Check Digit***

This selection allows you to specify whether the check digit should be transmitted at the end of Planet Code data. *Default = Don't Transmit.*



PLNCKX1.

**Transmit Check Digit**



PLNCKX0.

**\* Don't Transmit Check Digit**

## ***Postnet Check Digit***

This selection allows you to specify whether the check digit should be transmitted at the end of Postnet data. *Default = Don't Transmit.*



NETCKX1.

**Transmit Check Digit**



NETCKX0.

**\* Don't Transmit Check Digit**

## ***Australian Post Interpretation***

This option controls what interpretation is applied to customer fields in Australian 4-State symbols.

**Bar Output** lists the bar patterns in "0123" format.

**Numeric N Table** causes that field to be interpreted as numeric data using the N Table.

**Alphanumeric C Table** causes the field to be interpreted as alphanumeric data using the C Table. Refer to the Australian Post Specification Tables.

**Combination C and N Tables** causes the field to be interpreted using either the C or N Tables.



AUSINT0.

\* Bar Output



AUSINT1.

Numeric N Table



AUSINT2.

Alphanumeric C Table



AUSINT3.

Combination C and N Tables

## ***Postal Codes - Linear***

The following lists linear postal codes. Any combination of linear postal code selections can be active at a time.

### ***China Post (Hong Kong 2 of 5)***

*<Default All China Post (Hong Kong 2 of 5) Settings>*



CPCDFT.

---

## **China Post (Hong Kong 2 of 5) On/Off**



CPCENA1.

**On**



CPCENAD.

**\* Off**

## **China Post (Hong Kong 2 of 5) Message Length**

Scan the bar codes below to change the message length. Refer to [Message Length Description](#) (page 7-2) for additional information. Minimum and Maximum lengths = 2-80. Minimum Default = 4, Maximum Default = 80.



CPCMIN.

**Minimum Message Length**



CPCMAX.

**Maximum Message Length**

---

## **Korea Post**

*<Default All Korea Post Settings>*



KPCDFT.

### **Korea Post**



KPCENA1.

**On**



KPCENAD.

**\* Off**

### **Korea Post Message Length**

Scan the bar codes below to change the message length. Refer to [Message Length Description](#) (page 7-2) for additional information. Minimum and Maximum lengths = 2-80. Minimum Default = 4, Maximum Default = 48.



KPCMIN.

**Minimum Message Length**



KPCMAX.

**Maximum Message Length**

### **Korea Post Check Digit**

This selection allows you to specify whether the check digit should be transmitted at the end of the scanned data. *Default = Don't Transmit.*



KPCCHK1.

**Transmit Check Digit**



KPCCHK0.

**\* Don't Transmit Check Digit**



# Imaging Commands

The scanner is like a digital camera in the way it captures, manipulates, and transfers images. The following commands allow you to alter the way the scanner performs these functions.

*Note: If you are using the scanner in a stand, you must set the In-Stand Sensor Mode to Off in order to take images (see [In-Stand Sensor Mode](#) on page 4-12).*

## Single-Use Basis

Imaging Commands with their modifiers send instructions to the scanner on a single-use basis, and take effect for a single image capture. Once that capture is complete, the scanner reverts to its imaging default settings. If you want to permanently change a setting, you must use the serial default commands (see [Chapter 11](#)). When the serial default command is used, that selection becomes the new, permanent setting for the scanner.

## Command Syntax

Multiple modifiers and commands can be issued within one sequence. If additional modifiers are to be applied to the same command, just add the modifiers to that command. For example, to add 2 modifiers to the Image Snap command, such as setting the Imaging Style to 1P and the Wait for Trigger to 1T, you would enter **IMG SNP1P1T**.

*Note: After processing an image capture command (IMG SNP or IMG BOX), you must follow it with an IMG SHP command if you want to see it on your terminal.*

To add a command to a sequence, each new command is separated with a semicolon. For example, to add the Image Ship command to the above sequence, you would enter **IMG SNP1P1T;IMG SHP**.

The imaging commands are:

[Image Snap - IMG SNP](#) (page 8-2)

[Image Ship - IMG SHP](#) (page 8-5)

[Intelligent Signature Capture - IMG BOX](#) (page 8-14)

The modifiers for each of these commands follow the command description.

*Note: The images included with each command description are examples only. The results you achieve may be different from those included in this manual. The quality of the output you receive will vary depending on lighting, quality of the initial image/object being captured, and distance of the scanner from the image/object. To achieve a high quality image, it is recommended that you position your scanner 4-6" (10.2-15.2 cm) away from the image/object you are capturing.*

---

## Step 1 - Take a Picture Using IMGSNP

### Image Snap - IMGSNP

An image is taken whenever the hardware button is pressed, or when the Image Snap (IMGSNP) command is processed.

The image snap command has many different modifiers that can be used to change the look of the image in memory. Modifiers always begin with numbers and end with a letter (case insensitive). Any number of modifiers may be appended to the IMGSNP command. For example, you can use the following command to snap an image, increase the gain, and have the beeper sound once the snap is complete: **IMGSNP2G1B**

#### **IMGSNP Modifiers**

##### **P - Imaging Style**

This sets the Image Snap style.

- 0P **Decoding Style**. This processing allows a few frames to be taken until the exposure parameters are met. The last frame is then available for further use.
- 1P **Photo Style (default)**. This mimics a simple digital camera, and results in a visually optimized image.
- 2P **Manual Style**. This is an advanced style that should only be used by an experienced user. It allows you the most freedom to set up the scanner, and has no auto-exposure.

##### **B - Beeper**

Causes a beep to sound after an image is snapped.

- 0B No beep (*default*)
- 1B Sounds a beep when the image is captured.

##### **T - Wait for Trigger**

Waits for a hardware button push before taking the image. This is only available when using Photo Style (1P).

- 0T Takes image immediately (*default*)
- 1T Waits for a button push, then takes the image

##### **L - LED State**

Determines if the LEDs should be on or off, and when. Ambient illumination (0L) is preferred for taking pictures of color documents, such as ID cards, especially when the scanner is in a stand. LED illumination (1L) is preferred when the scanner is handheld. LED State is not available when using Decoding Style (0P).

- 0L LEDs off (*default*)
- 1L LEDs on

---

## E - Exposure

Exposure is used in Manual Style only (2P), and allows you to set the exposure time. This is similar to setting a shutter speed on a camera. The exposure time determines how long the scanner takes to record an image. On a bright day, exposure times can be very short because plenty of light is available to help record an image. At nighttime, exposure time can increase dramatically due to the near absence of light. Units are 127 microseconds. (Default = 7874)

nE Range: 1 - 7874

Example of Exposure at 7874E with fluorescent lighting:

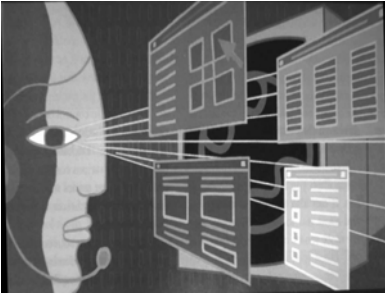

Example of Exposure at 100E with fluorescent lighting:



## G - Gain

Gain is used in Manual Style only (2P). Like a volume control, the gain modifier boosts the signal and multiplies the pixel value. As you increase the gain, the noise in an image is also amplified.

1G No gain (*default*)

2G Medium gain

4G Heavy gain

8G Maximum gain

Example of Gain at 1G:



Example of Gain at 4G:



Example of Gain at 8G:



---

## W - Target White Value

Sets the target for the median grayscale value in the captured image. For capturing close-up images of high contrast documents, a lower setting, such as 75, is recommended. Higher settings result in longer exposure times and brighter images, but if the setting is too high, the image may be overexposed. Target White Value is only available when using Photo Style (1P). (Default = 125)

nW Range: 0 - 255

Example of White Value at 75W:



Example of White Value at 125W:



Example of White Value at 200W:



## D - Delta for Acceptance

This sets the allowable range for the white value setting (see [W - Target White Value](#)). Delta is only available when using Photo Style (1P). (Default = 25)

nD Range: 0 - 255

## U - Update Tries

This sets the maximum number of frames the scanner should take to reach the [D - Delta for Acceptance](#). Update Tries is only available when using Photo Style (1P). (Default = 6)

nU Range: 0 - 10

## % - Target Set Point Percentage

Sets the target point for the light and dark values in the captured image. A setting of 75% means 75% of the pixels are at or below the target white value, and 25% of the pixels are above the target white value. Altering this setting from the default is not recommended under normal circumstances. To alter grayscale values, [W - Target White Value](#) should be used. (Default = 50)

n% Range: 1 - 99

Example of Target Set Point Percentage at 97%:

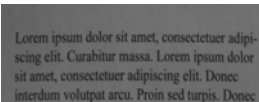

Example of Target Set Point Percentage at 50%:

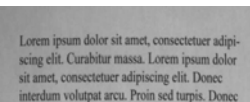

Example of Target Set Point Percentage at 40%:

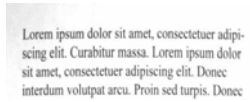

---

## Step 2 - Ship a Picture Using IMGSHIP

### Image Ship - IMGSHIP

An image is taken whenever the button is pressed, or when the Image Snap (IMGSNP) command is processed. The last image is always stored in memory. You can “ship” the image by using the IMGSHIP command.

The image ship commands have many different modifiers that can be used to change the look of the image output. Modifiers affect the image that is transmitted, but do not affect the image in memory. Modifiers always begin with a number and end with a letter (case insensitive). Any number of modifiers may be appended to the IMGSHIP command. For example, you can use the following command to snap and ship a bitmap image with gamma correction and document image filtering: **IMGSNP;IMGSHIP8F75K26U**

### IMGSHIP Modifiers

#### A - Infinity Filter

Enhances pictures taken from very long distances (greater than 10 feet or 3m). The Infinity Filter should not be used with [IMGSHIP Modifiers](#) (page 8-5).

0A Infinity filter off (*default*)

1A Infinity filter on

Example of Infinity Filter off (0A)  
from approximately 12 feet  
(3.66m) away:

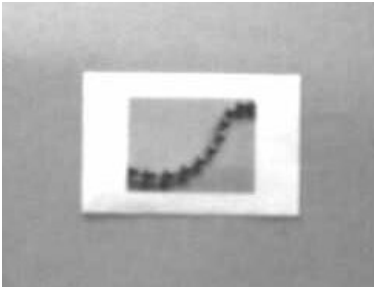

Example of Infinity Filter on (1A)  
from approximately 12 feet (3.66m)  
away:

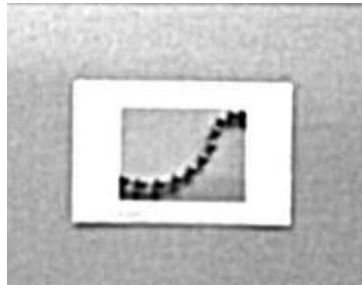

---

## C - Compensation

Flattens the image to account for variations in illumination across the image.

- 0C Compensation disabled (*default*)
- 1C Compensation enabled

Example of Compensation at 0C:



Example of Compensation at 1C:

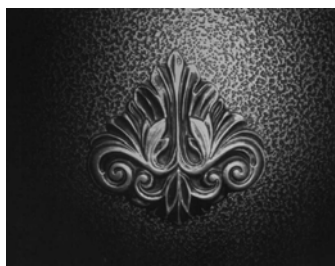

## D - Pixel Depth

Indicates the number of bits per pixel in the transmitted image (KIM or BMP format only).

- 8D 8 bits per pixel, grayscale image (*default*)
- 1D 1 bit per pixel, black and white image

---

## E - Edge Sharpen

An edge sharpen filter cleans up the edges of an image, making it look cleaner and sharper. While edge sharpening does make the image look cleaner, it also removes some fine detail from the original image. The strength of the edge sharpen filter can be entered from 1 to 24. Entering a 23E gives the sharpest edges, but also increases noise in the image.

0E Don't sharpen image (*default*)

14E Apply edge sharpen for typical image

*ne* Apply edge sharpen using strength *n* ( $n = 1-24$ )

Example of Edge Sharpen at 0E:



Example of Edge Sharpen at 24E:

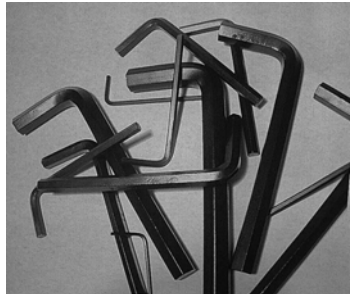

## F - File Format

Indicates the desired format for the image.

0F KIM format

1F TIFF binary

2F TIFF binary group 4, compressed

3F TIFF grayscale

4F Uncompressed binary (upper left to lower right, 1 pixel/bit, 0 padded end of line)

5F Uncompressed grayscale (upper left to lower right, bitmap format)

6F JPEG image (*default*)

8F BMP format (lower right to upper left, uncompressed)

10F TIFF color compressed image

11F TIFF color uncompressed image

12F JPEG color image

14F BMP color format

15F BMP Uncompressed raw image

---

## H - Histogram Stretch

Increases the contrast of the transmitted image. Not available with some image formats.

0H No stretch (*default*)

1H Histogram stretch

Example of Histogram Stretch at 0H:      Example of Histogram Stretch at 1H:



## I - Invert Image

Invert image is used to rotate the image around the X or Y axis.

1ix Invert around the X axis (flips picture upside down)

1iy Invert around the Y axis (flips picture left to right)

Example of image not inverted:



Example of image with Invert Image set to 1ix:



Example of image with Invert Image set to 1iy:





---

## IF- Noise Reduction

Used to reduce the salt and pepper noise in an image.

0if No salt and pepper noise reduction (default)

1if Salt and pepper noise reduction

Example of Noise Reduction Off (0if):

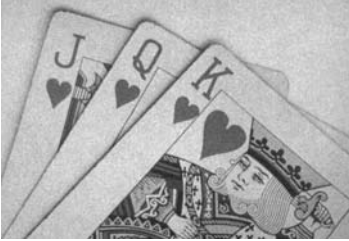

Example of Noise Reduction On (1if):



## IR - Image Rotate

0ir Image as snapped (rightside up) (default)

1ir Rotate image 90 degrees to the right

2ir Rotate image 180 degrees (upside down)

3ir Rotate image 90 degrees to the left

Example of Image Rotate set to 0ir:



Example of Image Rotate set to 2ir:



Example of Image Rotate set to 1ir:



Example of Image Rotate set to 3ir:



---

## J - JPEG Image Quality

Sets the desired quality when the JPEG image format is selected. Higher numbers result in higher quality, but larger files. Smaller numbers result in greater amounts of lossy compression, faster transmission times, lower quality, but smaller files. (*Default = 50*)

- n*J Image is compressed as much as possible while preserving quality factor of *n* (*n* = 0 - 100)
- 0J worst quality (smallest file)
- 100J best quality (largest file)

## K - Gamma Correction

Gamma measures the brightness of midtone values produced by the image. You can brighten or darken an image using gamma correction. A higher gamma correction yields an overall brighter image. The lower the setting, the darker the image. The optimal setting for text images is 50K.

- 0K Gamma correction off (*default*)
- 50K Apply gamma correction for brightening typical document image
- n*K Apply gamma correction factor *n* (*n* = 0-1,000)

Example of Gamma Correction set to 0K:



Example of Gamma Correction set to 50K:



Example of Gamma Correction set to 255K:



## L, R, T, B, M - Image Cropping

*Note: Image Cropping should not be used with [IMGSHP Modifiers](#) (see page 8-5).*

Ships a window of the image by specifying the left, right, top, and bottom pixel coordinates. Device columns are numbered 0 through 1279, and device rows are numbered 0 through 959.

- n*L The left edge of the shipped image corresponds to column *n* of the image in memory. Range: 000 - 843. (*Default = 0*)
- n*R The right edge of the shipped image corresponds to column *n* - 1 of the image in memory. Range: 000 - 843. (*Default = all columns*)
- n*T The top edge of the shipped image corresponds to row *n* of the image in memory. Range: 000 - 639. (*Default = 0*)

---

$nB$  The bottom edge of the shipped image corresponds to row  $n - 1$  of the image in memory. Range: 000 - 639. (Default = all rows)

Uncropped Image:



Example of Image Crop set to 300R:



Example of Image Crop set to 300L:

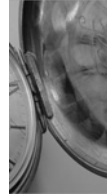

Example of Image Crop set to 200B:



Example of Image Crop set to 200T:



Alternately, specify the number of pixels to cut from the outside margin of the image; thus only the center pixels are transmitted.

$nM$  Margin: cut  $n$  columns from the left,  $n + 1$  columns from the right,  $n$  rows from the top, and  $n + 1$  rows from the bottom of the image. Ship the remaining center pixels. Range: 0 - 238. (Default = 0, or full image)

Example of Image Crop set to 238M:



## P - Protocol

Used for shipping an image. Protocol covers two features of the image data being sent to the host. It addresses the protocol used to send the data (Hmodem, which is an Xmodem 1K variant that has additional header information), and the format of the image data that is sent.

0P None (raw data)

2P None (default for USB)

3P Hmodem compressed (default for RS232)

4P Hmodem

## S - Pixel Ship

Pixel Ship sizes an image in proportion to its original size. It decimates the image by shipping only certain, regularly spaced pixels. For example, **4S** would transmit every fourth pixel from every fourth line. The smaller number of pixels shipped, the smaller the image, however, after a certain point the image becomes unusable.

- 1S ship every pixel (*default*)
- 2S ship every 2nd pixel, both horizontally and vertically
- 3S ship every 3rd pixel, both horizontally and vertically

Example of Pixel Ship set to 1S:



Example of Pixel Ship set to 2S:



Example of Pixel Ship set to 3S:



### U - Document Image Filter

Allows you to input parameters to sharpen the edges and smooth the area between the edges of text in an image. This filter should be used with gamma correction (see [page 8-10](#)), with the scanner in a stand, and the image captured using the command:

#### IMG SNP1POL168W90%32U

This filter typically provides better JPEG compression than the standard E - Edge Sharpen command (see [page 8-13](#)). This filter also works well when shipping pure black and white images (1 bit per pixel). The optimal setting is 26U.

- 0U Document image filter off (*default*)
- 26U Apply document image filter for typical document image
- nU Apply document image filter using grayscale threshold n. Use lower numbers when the image contrast is lower. 1U will have a similar effect to setting [E - Edge Sharpen](#) (page 8-7) to 22e. Range: 0-255.

Example of Document Image Filter set to 0U:



Example of Document Image Filter set to 26U:



---

## V - Blur Image

Smooths transitions by averaging the pixels next to the hard edges of defined lines and shaded areas in an image.

0V Don't blur (*default*)

1V Blur

Example of Blur Image Off (0V):



Example of Blur Image On (1V):



## W - Histogram Ship

A histogram gives a quick picture of the tonal range of an image, or key type. A low-key image has detail concentrated in the shadows; a high-key image has detail concentrated in the highlights; and an average-key image has detail concentrated in the midtones. This modifier ships the histogram for an image.

0W Don't ship histogram (*default*)

1W Ship histogram

Image used for histogram:

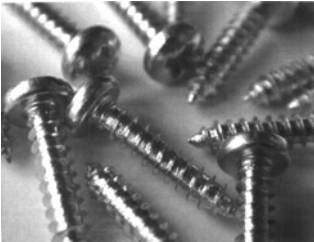

Histogram of image at left:



---

## **Image Size Compatibility**

If you have applications that expect an image ship to return exactly 640x480 pixels, scan the Force VGA Resolution bar code. *Default = Native Resolution*



IMGVGA1.

**Force VGA Resolution**



IMGVGA0.

**\* Native Resolution**

## **Intelligent Signature Capture - IMGBOX**

IMGBOX allows you to configure the size and location of a signature capture area relative to its proximity to a bar code. This allows you to tailor a signature capture area to a specific form. In order to use IMGBOX, you need a set form where the signature box location is in a known location relative to a bar code. You can input the overall size of the signature area, as well as specify how far the signature area is from the bar code, vertically and horizontally. You can also set the resolution and file format for the final output of the signature capture image.

*Note: IMGBOX commands can only be triggered by one of the following types of bar codes: PDF417, Code 39, Code 128, Aztec, Codabar, and Interleaved 2 of 5. Once one of these symbologies has been read, the image is retained for a possible IMGBOX command.*

## **Signature Capture Optimize**

If you will be using your scanner to capture signatures frequently, you should optimize it for this purpose. However, the speed of scanning bar codes may be slowed when this mode is enabled. *Default = Off.*



DECBND1.

**Optimize On**



DECBND0.

**\* Optimize Off**

---

The following IMGBOX example was executed and viewed using QuickView software. This software is available at [www.honeywellaidc.com](http://www.honeywellaidc.com). Click on **Software Downloads**. Select **4600r** from the Products list, then select **QuickView Software Utility**.

Below is an example of a signature capture application. In this example, the aimer is centered over the signature capture area and the trigger is pressed. A single beep is emitted, indicating that the scanner has read a Code 128 bar code and the data has been transferred to the host. An IMGBOX command may now be sent from the host to specify the coordinates of the signature capture area below that code, and indicating that only that area containing the signature should be transferred as an image to the host.

To see this example, align the aimer with the signature area (not with the bar code), then press the trigger.



Send the following IMGBOX command string after the button push:

**Example:** *IMGBOX245w37h55y.*

*Note: Case is not important in the command string. It is used here only for clarity.*

The following image is captured:

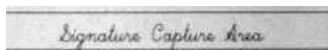

The IMGBOX commands have many different modifiers that can be used to change the size and appearance of the signature image output by the scanner. Modifiers affect the image that is transmitted, but do not affect the image in memory. Modifiers always begin with a number and end with a letter (case insensitive). Any number of modifiers may be appended to the IMGBOX command.

*Note: The IMGBOX command will return a NAK unless a window size (width and height) are specified. See [H - Height of Signature Capture Area](#) (page 8-17) and [W - Width of Signature Capture Area](#) (page 8-18).*

## **IMGBOX Modifiers**

### **A - Output Image Width**

---

This option is used to size the image horizontally. If using this option, set the resolution (R) to zero.

Example of Image Width set to 200A:

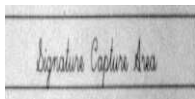

Example of Image Width set to 600A:

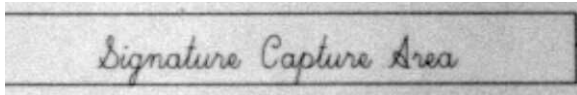

### **B - Output Image Height**

This option is used to size the image vertically. If using this option, set the resolution (R) to zero.

Example of Image Height set to 50B:

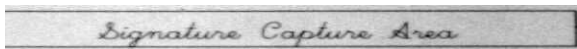

Example of Image Height set to 100B:

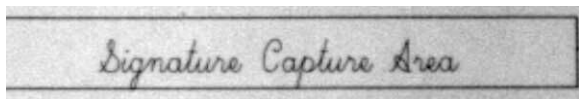

### **D - Pixel Depth**

This indicates the number of bits per pixel in the transmitted image, which defines whether it will be grayscale or black and white.

8D 8 bits per pixel, grayscale image (*default*)

1D 1 bit per pixel, black and white image

### **F - File Format**

This option indicates the type of file format in which to save the image.

0F KIM format

1F TIFF binary

2F TIFF binary group 4, compressed

3F TIFF grayscale

4F Uncompressed Binary

5F Uncompressed grayscale

6F JPEG image (*default*)

7F Outlined image



---

8F BMP format

### H - Height of Signature Capture Area

The height of the signature capture area must be measured in inches divided by .01. In the example, the height of the area to be captured is 3/8 inch, resulting in a value of  $H = .375/0.01 = 37.5$ .

Example: *IMGBOX245w***37h***55y*.

### K - Gamma Correction

Gamma measures the brightness of midtone values produced by the image. You can brighten or darken an image using gamma correction. A higher gamma correction yields an overall brighter image. The lower the setting, the darker the image. The optimal setting for text images is 50K.

0K Gamma correction off (*default*)

50K Apply gamma correction for brightening typical document image

nK Apply gamma correction factor  $n$  ( $n = 1-255$ )

Example of Gamma Correction set to 0K:



Example of Gamma Correction set to 50K:



Example of Gamma Correction set to 255K:

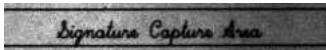

### R - Resolution of Signature Capture Area

The resolution is the number of pixels that the scanner outputs per each minimum bar width. The higher the value for R, the higher the quality of the image, but also the larger the file size. Values begin at 1000. The scanner automatically inserts a decimal point between the first and second digit.

---

For example, use 2500 to specify a resolution of 2.5. Set to zero when using the A and B modifiers (see [A - Output Image Width](#) and [B - Output Image Height](#) on page 8-16).

Example of Resolution set to 0R:

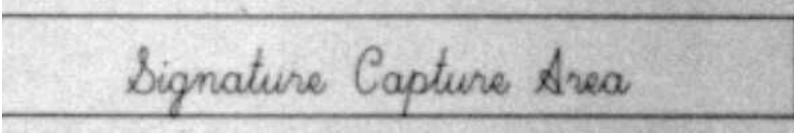

Example of Resolution set to 1000R:

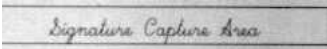

Example of Resolution set to 2000R:

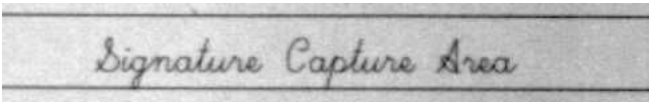

### S - Bar Code Aspect Ratio

All dimensions used in IMGBOX are measured as multiples of the minimum element size of the bar code. The bar code aspect ratio allows you to set the ratio of the bar code height to the narrow element width. In the example, the narrow element width is .010 inches and the bar code height is 0.400 inches, resulting in a value of  $S = 0.4/0.01 = 40$ .

### W - Width of Signature Capture Area

The width of the signature capture area must be measured in inches divided by .01. In the example, the width of the area to be captured is 2.4 inches, resulting in a value of  $W = 2.4/0.01 = 240$ . (A value of 245 was used in the example to accommodate a slightly wider image area.)

Example: `IMGBOX245w37h55y`.

### X - Horizontal Bar Code Offset

The horizontal bar code offset allows you to offset the horizontal center of the signature capture area. Positive values move the horizontal center to the right and negative values to the left. Measurements are in multiples of the minimum bar width.

Example of Horizontal Offset set to 75X:

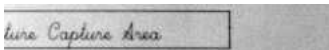

Example of Horizontal Offset set to -75X:

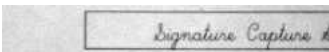

---

## Y - Vertical Bar Code Offset

The vertical bar code offset allows you to offset the vertical center of the signature capture area. Negative numbers indicate that the signature capture is above the bar code, and positive numbers indicate that the area is below the bar code. Measurements are in multiples of the minimum bar width.

Example of Vertical Offset set to -7Y:



Example of Vertical Offset set to 65Y:

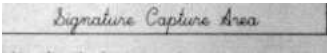

## RF Default Imaging Device

The scanner supports imaging command processing (IMGSH, IMGSNP, IMG-BOX) so that EZConfig-Scanning (see page 10-3) and other applications are able to perform imaging functions as if they were communicating directly with a scanner. To accomplish this, the scanner uses a menu command called RF\_DID (RF Default Imaging Device). RF\_DID is the name of the scanner (BT\_NAM) that is to receive imaging commands. The default for RF\_DID is "" indicating that imaging commands are to be sent to all associated scanners. Change this setting to RF\_DIDscanner\_name to ensure that they are sent to a particular scanner. Refer to "Paging" on page 3-9 to generate a report containing the port, work group, scanner name, and address for each scanner. Refer to "Scanner Name" on page 3-25 set a unique name for each scanner.



## Keyboard Function Relationships

The following Keyboard Function Code, Hex/ASCII Value, and Full ASCII “CTRL”+ relationships apply to all terminals that can be used with the scanner. Refer to [page 2-18](#) enable Control + ASCII mode.

Function Code	HEX/ASCII Value	Full ASCII “CTRL” +
NUL	00	@
SOH	01	A
STX	02	B
ETX	03	C
EOT	04	D
ENQ	05	E
ACK	06	F
BEL	07	G
BS	08	H
HT	09	I
LF	0A	J
VT	0B	K
FF	0C	L
CR	0D	M
SO	0E	N
SI	0F	O
DLE	10	P
DC1	11	Q
DC2	12	R
DC3	13	S
DC4	14	T
NAK	15	U
SYN	16	V
ETB	17	W
CAN	18	X
EM	19	Y
SUB	1A	Z
ESC	1B	[
FS	1C	\
GS	1D	]
RS	1E	^
US	1F	_

The last five characters in the Full ASCII "CTRL" column ([ \ ] 6 - ), apply to US only. The following chart indicates the equivalents of these five characters for different countries.

Country	Codes				
United States	[	\	]	6	-
Belgium	[	<	]	6	-
Scandinavia	8	<	9	6	-
France	^	8	\$	6	=
Germany		Ã	+	6	-
Italy		\	+	6	-
Switzerland		<	..	6	-
United Kingdom	[	ç	]	6	-
Denmark	8	\	9	6	-
Norway	8	\	9	6	-
Spain	[	\	]	6	-

---

## ***Supported Interface Keys***

<b>ASCII</b>	<b>HEX</b>	<b>IBM PC/AT and Compatibles, USB PC Keyboard</b>	<b>Apple Mac/iMac Supported Keys</b>
NUL	00	Reserved	Reserved
SOH	01	Enter (KP)	Enter/Numpad Enter
STX	02	Cap Lock	CAPS
ETX	03	ALT make	ALT make
EOT	04	ALT break	ALT break
ENQ	05	CTRL make	CNTRL make
ACK	06	CTRL break	CNTRL break
BEL	07	CR/Enter	RETURN
BS	08	Reserved	APPLE make
HT	09	Tab	TAB
LF	0A	Reserved	APPLE break
VT	0B	Tab	TAB
FF	0C	Delete	Del
CR	0D	CR/Enter	RETURN
SO	0E	Insert	Ins Help
SI	0F	Escape	ESC
DLE	10	F11	F11
DC1	11	Home	Home
DC2	12	Print	Prnt Scrn
DC3	13	Back Space	BACKSPACE
DC4	14	Back Tab	LSHIFT TAB
NAK	15	F12	F12
SYN	16	F1	F1
ETB	17	F2	F2
CAN	18	F3	F3
EM	19	F4	F4
SUB	1A	F5	F5
ESC	1B	F6	F6
FS	1C	F7	F7
GS	1D	F8	F8
RS	1E	F9	F9
US	1F	F10	F10
DEL	7F		BACKSPACE





## ***To Add a Test Code I.D. Prefix to All Symbologies***

This selection allows you to turn on transmission of a Code I.D. before the decoded symbology. (See the [Symbology Chart](#), beginning on page A-1) for the single character code that identifies each symbology.) This action first clears all current prefixes, then programs a Code I.D. prefix for all symbologies. This is a temporary setting that will be removed when the unit is power cycled.



PRECA2\_BK2995C80!

**Add Code I.D. Prefix to  
All Symbologies (Temporary)**

## ***Show Decoder Revision***

Scan the bar code below to output the decoder revision.



REV\_DR.

**Show Decoder Revision**

## ***Show Scan Driver Revision***

Scan the bar code below to output the scan driver revision. The scan driver controls image capture.



REV\_SD.

**Show Scan Driver Revision**

## ***Show Software Revision***

Scan the bar code below to output the current software revision, unit serial number, and other product information for both the scanner and base.



REVINF.

**Show Revision**

---

## Show Data Format

Scan the bar code below to show current data format settings.



DFMBK3?.

Data Format Settings

## Test Menu

When you scan the Test Menu **On** code, then scan a programming code in this manual, the scanner displays the content of a programming code. The programming function will still occur, but in addition, the content of that programming code is output to the terminal.

*Note: This feature should not be used during normal scanner operation.*



TSTMNU1.

On



TSTMNU0.

\* Off

## TotalFreedom

TotalFreedom is an open system architecture that makes it possible for you create applications that reside on your scanner. Decoding apps and Data Formatting apps can be created using TotalFreedom. For further information about TotalFreedom, go to our website at [www.honeywellaidc.com](http://www.honeywellaidc.com).

---

## Application Plug-Ins (Apps)

Any apps that you are using can be turned off or on by scanning the following bar codes. Apps are stored in groups: Decoding, and Formatting. You can enable and disable these groups of apps by scanning that group's **On** or **Off** bar code below. You can also scan the **List Apps** bar code to output a list of all your apps.



PLGDCE1.

\* Decoding Apps On



PLGFOE1.

\* Formatting Apps On



PLGINF.

List Apps



PLGDCE0.

Decoding Apps Off



PLGFOE0.

Formatting Apps Off

*Note: You must reset your device in order for the apps setting to take effect.*

## EZConfig-Scanning Introduction

EZConfig-Scanning provides a wide range of PC-based programming functions that can be performed on a scanner connected to your PC's COM port. EZConfig-Scanning allows you to download upgrades to the scanner's firmware, change programmed parameters, and create and print programming bar codes. Using EZConfig-Scanning, you can even save/open the programming parameters for a scanner. This saved file can be e-mailed or, if required, you can create a single bar code that contains all the customized programming parameters and mail or fax that bar code to any location. Users in other locations can scan the bar code to load in the customized programming.

To communicate with a scanner, EZConfig-Scanning requires that the PC have at least one available serial communication port, or a serial port emulation using a physical USB port. If you are using the serial port and RS232 cable, an external power supply is required. When using a USB serial port emulation, only a USB cable is required.

## EZConfig-Scanning Operations

The EZConfig-Scanning software performs the following operations:

---

## **Scan Data**

Scan Data allows you to scan bar codes and display the bar code data in a window. Scan Data lets you send serial commands to the scanner and receive scanner response that can be seen in the Scan Data window. The data displayed in the Scan Data window can either be saved in a file or printed.

## **Configure**

Configure displays the programming and configuration data of the scanner. The scanner's programming and configuration data is grouped into different categories. Each category is displayed as a tree item under the "Configure" tree node in the application explorer. When one of these tree nodes is clicked, the right-hand side is loaded with the parameters' form belonging to that particular category. The "Configure" tree option has all the programming and configuration parameters specified for a scanner. You can set or modify these parameters as required. You can later write the modified settings to the scanner, or save them to a dcf file.

## **Imaging**

Imaging provides all the image-related functions that a 2D Scanner can perform. You can capture an image using the current settings, and the image will be displayed in an image window. Images captured from the scanner can be saved to files in different image formats. You can modify the image settings and save the image settings to an INI file, which can be loaded later to capture new images. Imaging also lets you preview the images continuously captured by the scanner.

## **Installing EZConfig-Scanning from the Web**

*Note: EZConfig-Scanning requires .NET software. If .NET is not installed on your PC, you will be prompted to install it during the EZConfig-Scanning installation.*

1. Access the Honeywell web site at [www.honeywellaidc.com](http://www.honeywellaidc.com)
2. Click on the **Resources** tab. Select **Software**.
3. Click on the dropdown for **Select Product Number**. Click on **1900** or **1902**.
4. Click on the listing for **EZConfig-Scanning**.
5. When prompted, select **Save File**, and save the files to the **c:\windows\temp** directory.
6. Once you have finished downloading the file, exit the web site.
7. Using Explorer, go to the **c:\windows\temp** file.
8. Double click on the **Setup.exe** file. Follow the screen prompts to install the EZConfig-Scanning program.

- 
9. If you've selected the defaults during installation, you can click on **Start Menu-All Programs-Honeywell-EZConfig-Scanning**.



# Serial Programming Commands

The serial programming commands can be used in place of the programming bar codes. Both the serial commands and the programming bar codes will program the scanner. For complete descriptions and examples of each serial programming command, refer to the corresponding programming bar code in this manual.

The device must be set to an RS232 interface (see [page 2-2](#)). The following commands can be sent via a PC COM port using terminal emulation software.

## Conventions

The following conventions are used for menu and query command descriptions:

- parameter* A label representing the actual value you should send as part of a command.
- [*option*] An optional part of a command.
- {*Data*} Alternatives in a command.
- bold** Names of menus, menu commands, buttons, dialog boxes, and windows that appear on the screen.

## Menu Command Syntax

Menu commands have the following syntax (spaces have been used for clarity only):

*Prefix* [:*Name*:] *Tag* *SubTag* {*Data*} [, *SubTag* {*Data*}] [: *Tag* *SubTag* {*Data*}] [...]  
*Storage*

**Prefix** Three ASCII characters: **SYN M CR** (ASCII 22,77,13).

**:Name:** To send information to the scanner (with the base connected to host), use :Xenon: The default factory setting for a Xenon scanner is Xenon scanner. This setting is changed by using the BT\_NAM command, which accepts alphanumeric values. If the name is not known, a wildcard (\*) can be used :\*..

*Note:* *Since the base stores all work group settings and transfers to them to scanner once they are linked, changes are typically done to the base and not to the scanner.*

**Tag** A 3 character case-insensitive field that identifies the desired menu command group. For example, all RS232 configuration settings are identified with a Tag of **232**.

**SubTag** A 3 character case-insensitive field that identifies the desired menu command within the tag group. For example, the SubTag for the RS232 baud rate is **BAD**.

**Data** The new value for a menu setting, identified by the Tag and SubTag.

---

**Storage** A single character that specifies the storage table to which the command is applied. An exclamation point (!) performs the command's operation on the device's volatile menu configuration table. A period (.) performs the command's operation on the device's non-volatile menu configuration table. Use the non-volatile table only for semi-permanent changes you want saved through a power cycle.

## **Query Commands**

Several special characters can be used to query the device about its settings.

- ^ What is the default value for the setting(s).
- ? What is the device's current value for the setting(s).
- \* What is the range of possible values for the setting(s). (The device's response uses a dash (-) to indicate a continuous range of values. A pipe (|) separates items in a list of non-continuous values.)

### ***:Name: Field Usage (Optional)***

This command returns the query information from the scanner.

### ***Tag Field Usage***

When a query is used in place of a Tag field, the query applies to the *entire* set of commands available for the particular storage table indicated by the Storage field of the command. In this case, the SubTag and Data fields should not be used because they are ignored by the device.

### ***SubTag Field Usage***

When a query is used in place of a SubTag field, the query applies only to the subset of commands available that match the Tag field. In this case, the Data field should not be used because it is ignored by the device.

### ***Data Field Usage***

When a query is used in place of the Data field, the query applies only to the specific command identified by the Tag and SubTag fields.

### ***Concatenation of Multiple Commands***

Multiple commands can be issued within one Prefix/Storage sequence. Only the Tag, SubTag, and Data fields must be repeated for each command in the sequence. If additional commands are to be applied to the same Tag, then the new command sequence is separated with a comma (,) and only the SubTag and Data fields of the additional command are issued. If the additional command requires a different Tag field, the command is separated from previous commands by a semicolon (;).



---

## ***Responses***

The device responds to serial commands with one of three responses:

**ACK** Indicates a good command which has been processed.

**ENQ** Indicates an invalid Tag or SubTag command.

**NAK** Indicates the command was good, but the Data field entry was out of the allowable range for this Tag and SubTag combination, e.g., an entry for a minimum message length of 100 when the field will only accept 2 characters.

When responding, the device echoes back the command sequence with the status character inserted directly before each of the punctuation marks (the period, exclamation point, comma, or semicolon) in the command.

## ***Examples of Query Commands***

In the following examples, a bracketed notation [ ] depicts a non-displayable response.

**Example:** What is the range of possible values for Codabar Coding Enable?

**Enter:**        **cbrena\*.**

**Response:** **CBRENA0-1[ACK]**

This response indicates that Codabar Coding Enable (CBRENA) has a range of values from 0 to 1 (off and on).

**Example:** What is the default value for Codabar Coding Enable?

**Enter:**        **cbrena^.**

**Response:** **CBRENA1[ACK]**

This response indicates that the default setting for Codabar Coding Enable (CBRENA) is 1, or on.

**Example:** What is the device's current setting for Codabar Coding Enable?

**Enter:**        **cbrena?.**

**Response:** **CBRENA1[ACK]**

This response indicates that the device's Codabar Coding Enable (CBRENA) is set to 1, or on.

**Example:** What are the device's settings for all Codabar selections?

**Enter:**        **cbr?.**

**Response:** **CBRENA1[ACK],**  
**SSX0[ACK],**  
**CK20[ACK],**  
**CCT1[ACK],**  
**MIN2[ACK],**

---

**MAX60[ACK],  
DFT[ACK].**

This response indicates that the device's Codabar Coding Enable (CBRENA) is set to 1, or on;  
the Start/Stop Character (SSX) is set to 0, or Don't Transmit;  
the Check Character (CK2) is set to 0, or Not Required;  
concatenation (CCT) is set to 1, or Enabled;  
the Minimum Message Length (MIN) is set to 2 characters;  
the Maximum Message Length (MAX) is set to 60 characters;  
and the Default setting (DFT) has no value.

## **Trigger Commands**

You can activate and deactivate the scanner with serial trigger commands. First, the scanner must be put in Manual Trigger Mode by scanning a Manual Trigger Mode bar code ([page 4-6](#)), or by sending a serial menu command for triggering ([page 4-7](#)). Once the scanner is in serial trigger mode, the trigger is activated and deactivated by sending the following commands:

Activate: **SYN T CR**

Deactivate: **SYN U CR**

The scanner scans until a bar code has been read, until the deactivate command is sent, or until the serial time-out has been reached (see "Read Time-Out" on [page 4-7](#) for a description, and the serial command on [page 11-18](#)).

## **Resetting the Custom Defaults**

If you want the custom default settings restored to your scanner, scan the **Activate Custom Defaults** bar code below. This resets the scanner to the custom default settings. If there are no custom defaults, it will reset the scanner to the factory default settings. Any settings that have not been specified through the custom defaults will be defaulted to the factory default settings.



### **Activate Custom Defaults**

*Note: If using a cordless system, scanning this bar code also causes both the scanner and the base or Access Point to perform a reset and become unlinked. The scanner must be placed in its base to re-establish the link. If using an Access Point, the linking bar code must be scanned. See [Cordless System Operation](#) beginning on [page 3-1](#) for additional information.*

The charts on the following pages list the factory default settings for each of the commands (indicated by an asterisk (\*) on the programming pages).

## Menu Commands

Selection	Setting <i>* Indicates default</i>	Serial Command <i># Indicates a numeric entry</i>	Page
<b>Product Default Settings</b>			
Setting Custom Defaults	Set Custom Defaults	MNUCDP	1-10
	Save Custom Defaults	MNUCDS	1-10
Resetting the Custom Defaults	Activate Custom Defaults	DEFAULT	1-11
Resetting the Factory Defaults	Remove Custom Defaults	DEFOVR	1-11
	Activate Defaults	DEFAULT	1-11
Resetting the Factory Defaults - cordless scanners	Factory Default Settings: All Application Groups	PAPDFT&	3-28
Resetting the Custom Defaults - cordless scanners	Custom Default Settings: All Application Groups	PAPDFT	3-29
<b>Programming the Interface</b>			
Plug and Play Codes	Keyboard Wedge: IBM PC AT and Compatibles with CR suffix	PAP_AT	2-1
	Laptop Direct Connect with CR suffix	PAPLTD	2-1
	RS232 Serial Port	PAP232	2-2

<b>Selection</b>	<b>Setting</b> <i>* Indicates default</i>	<b>Serial Command</b> <i># Indicates a numeric entry</i>	<b>Page</b>
Plug and Play Codes: RS485	IBM Port 5B Interface	PAPP5B	<a href="#">2-2</a>
	IBM Port 9B HHBCR-1 Interface	PAP9B1	<a href="#">2-2</a>
	IBM Port 17 Interface	PAPP17	<a href="#">2-2</a>
	IBM Port 9B HHBCR-2 Interface	PAP9B2	<a href="#">2-2</a>
	RS485 Packet Mode On	RTLPDF1	<a href="#">2-3</a>
	RS485 Packet Mode Off	RTLPDF0	<a href="#">2-3</a>
	RS485 Packet Length (20-256)	RTLMPS	<a href="#">2-3</a>
Plug and Play Codes: IBM SurePos	USB IBM SurePos Handheld	PAPSPH	<a href="#">2-4</a>
	USB IBM SurePos Tabletop	PAPSPT	<a href="#">2-4</a>
Plug and Play Codes: USB	USB Keyboard (PC)	PAP124	<a href="#">2-4</a>
	USB Keyboard (Mac)	PAP125	<a href="#">2-4</a>
	USB Japanese Keyboard (PC)	TRMUSB134	<a href="#">2-4</a>
	USB HID	PAP131	<a href="#">2-5</a>
	USB Serial	TRMUSB130	<a href="#">2-5</a>
	CTS/RTS Emulation On	USBCTS1	<a href="#">2-5</a>
	CTS/RTS Emulation Off*	USBCTS0	<a href="#">2-5</a>
	ACK/NAK Mode On	USBACK1	<a href="#">2-5</a>
	ACK/NAK Mode Off*	USBACK0	<a href="#">2-5</a>

<b>Selection</b>	<b>Setting</b> <i>* Indicates default</i>	<b>Serial Command</b> <i># Indicates a numeric entry</i>	<b>Page</b>
Plug and Play Codes	Verifone Ruby Terminal	PAPRBY	<a href="#">2-6</a>
	Gilbarco Terminal	PAPGLB	<a href="#">2-6</a>
	Honeywell Bioptic Aux Port	PAPBIO	<a href="#">2-7</a>
	Datalogic Magellan Bioptic Aux Port	PAPMAG	<a href="#">2-7</a>
	NCR Bioptic Aux Port	PAPNCR	<a href="#">2-7</a>
	Wincor Nixdorf Terminal	PAPWNX	<a href="#">2-8</a>
	Wincor Nixdorf Beetle	PAPBTL	<a href="#">2-8</a>
Program Keyboard Country	*U.S.A.	KBDCTY0	<a href="#">2-9</a>
	Albania	KBDCTY35	<a href="#">2-9</a>
	Azeri (Cyrillic)	KBDCTY81	<a href="#">2-9</a>
	Azeri (Latin)	KBDCTY80	<a href="#">2-9</a>
	Belarus	KBDCTY82	<a href="#">2-9</a>
	Belgium	KBDCTY1	<a href="#">2-9</a>
	Bosnia	KBDCTY33	<a href="#">2-9</a>
	Brazil	KBDCTY16	<a href="#">2-9</a>
	Brazil (MS)	KBDCTY59	<a href="#">2-10</a>
	Bulgaria (Cyrillic)	KBDCTY52	<a href="#">2-10</a>
	Bulgaria (Latin)	KBDCTY53	<a href="#">2-10</a>
	Canada (French legacy)	KBDCTY54	<a href="#">2-10</a>
	Canada (French)	KBDCTY18	<a href="#">2-10</a>
	Canada (Multilingual)	KBDCTY55	<a href="#">2-10</a>
Croatia	KBDCTY32	<a href="#">2-10</a>	
Czech	KBDCTY15	<a href="#">2-10</a>	

<b>Selection</b>	<b>Setting</b> <i>* Indicates default</i>	<b>Serial Command</b> <i># Indicates a numeric entry</i>	<b>Page</b>
Program Keyboard Country	Czech (Programmers)	KBDCTY40	<a href="#">2-10</a>
	Czech (QWERTY)	KBDCTY39	<a href="#">2-10</a>
	Czech (QWERTZ)	KBDCTY38	<a href="#">2-10</a>
	Denmark	KBDCTY8	<a href="#">2-10</a>
	Dutch (Netherlands)	KBDCTY11	<a href="#">2-10</a>
	Estonia	KBDCTY41	<a href="#">2-11</a>
	Faeroese	KBDCTY83	<a href="#">2-11</a>
	Finland	KBDCTY2	<a href="#">2-11</a>
	France	KBDCTY3	<a href="#">2-11</a>
	Gaelic	KBDCTY84	<a href="#">2-11</a>
	Germany	KBDCTY4	<a href="#">2-11</a>
	Greek	KBDCTY17	<a href="#">2-11</a>
	Greek (220 Latin)	KBDCTY64	<a href="#">2-11</a>
	Greek (220)	KBDCTY61	<a href="#">2-11</a>
	Greek (319 Latin)	KBDCTY65	<a href="#">2-11</a>
	Greek (319)	KBDCTY62	<a href="#">2-11</a>
	Greek (Latin)	KBDCTY63	<a href="#">2-11</a>
	Greek (MS)	KBDCTY66	<a href="#">2-11</a>
	Greek (Polytonic)	KBDCTY60	<a href="#">2-12</a>
	Hebrew	KBDCTY12	<a href="#">2-12</a>
	Hungarian (101 key)	KBDCTY50	<a href="#">2-12</a>
	Hungary	KBDCTY19	<a href="#">2-12</a>
	Iceland	KBDCTY75	<a href="#">2-12</a>
	Irish	KBDCTY73	<a href="#">2-12</a>
	Italian (142)	KBDCTY56	<a href="#">2-12</a>
	Italy	KBDCTY5	<a href="#">2-12</a>
	Japan ASCII	KBDCTY28	<a href="#">2-12</a>
	Kazakh	KBDCTY78	<a href="#">2-12</a>
	Kyrgyz (Cyrillic)	KBDCTY79	<a href="#">2-12</a>
	Latin America	KBDCTY14	<a href="#">2-12</a>
Latvia	KBDCTY42	<a href="#">2-12</a>	

<b>Selection</b>	<b>Setting</b> <i>* Indicates default</i>	<b>Serial Command</b> <i># Indicates a numeric entry</i>	<b>Page</b>
Program Keyboard Country	Latvia (QWERTY)	KBDCTY43	<a href="#">2-13</a>
	Lithuania	KBDCTY44	<a href="#">2-13</a>
	Lithuania (IBM)	KBDCTY45	<a href="#">2-13</a>
	Macedonia	KBDCTY34	<a href="#">2-13</a>
	Malta	KBDCTY74	<a href="#">2-13</a>
	Mongolian (Cyrillic)	KBDCTY86	<a href="#">2-13</a>
	Norway	KBDCTY9	<a href="#">2-13</a>
	Poland	KBDCTY20	<a href="#">2-13</a>
	Polish (214)	KBDCTY57	<a href="#">2-13</a>
	Polish (Programmers)	KBDCTY58	<a href="#">2-13</a>
	Portugal	KBDCTY13	<a href="#">2-13</a>
	Romania	KBDCTY25	<a href="#">2-13</a>
	Russia	KBDCTY26	<a href="#">2-13</a>
	Russian (MS)	KBDCTY67	<a href="#">2-14</a>
	Russian (Typewriter)	KBDCTY68	<a href="#">2-14</a>
	SCS	KBDCTY21	<a href="#">2-14</a>
	Serbia (Cyrillic)	KBDCTY37	<a href="#">2-14</a>
	Serbia (Latin)	KBDCTY36	<a href="#">2-14</a>
	Slovakia	KBDCTY22	<a href="#">2-14</a>
	Slovakia (QWERTY)	KBDCTY49	<a href="#">2-14</a>
	Slovakia (QWERTZ)	KBDCTY48	<a href="#">2-14</a>
	Slovenia	KBDCTY31	<a href="#">2-14</a>
	Spain	KBDCTY10	<a href="#">2-14</a>
	Spanish variation	KBDCTY51	<a href="#">2-14</a>
	Sweden	KBDCTY23	<a href="#">2-14</a>
	Switzerland (French)	KBDCTY29	<a href="#">2-14</a>
	Switzerland (German)	KBDCTY6	<a href="#">2-15</a>
	Tatar	KBDCTY85	<a href="#">2-15</a>
	Turkey F	KBDCTY27	<a href="#">2-15</a>
	Turkey Q	KBDCTY24	<a href="#">2-15</a>

<b>Selection</b>	<b>Setting</b> <i>* Indicates default</i>	<b>Serial Command</b> <i># Indicates a numeric entry</i>	<b>Page</b>
Program Keyboard Country	Ukrainian	KBDCTY76	<a href="#">2-15</a>
	United Kingdom	KBDCTY7	<a href="#">2-15</a>
	United States (Dvorak right)	KBDCTY89	<a href="#">2-15</a>
	United States (Dvorak left)	KBDCTY88	<a href="#">2-15</a>
	United States (Dvorak)	KBDCTY87	<a href="#">2-15</a>
	United States (International)	KBDCTY30	<a href="#">2-15</a>
	Uzbek (Cyrillic)	KBDCTY77	<a href="#">2-15</a>
Keyboard Conversion	*Keyboard Conversion Off	KBDCNV0	<a href="#">2-17</a>
	Convert all Characters to Upper Case	KBDCNV1	<a href="#">2-17</a>
	Convert all Characters to Lower Case	KBDCNV2	<a href="#">2-17</a>
Keyboard Style	*Regular	KBDSTY0	<a href="#">2-16</a>
	Caps Lock	KBDSTY1	<a href="#">2-16</a>
	Shift Lock	KBDSTY2	<a href="#">2-16</a>
	Automatic Caps Lock	KBDSTY6	<a href="#">2-16</a>
	Emulate External Keyboard	KBDSTY5	<a href="#">2-17</a>
Control Character Output	*Control Character Output Off	KBDNPE0	<a href="#">2-18</a>
	*Control Character Output On	KBDNPE1	<a href="#">2-18</a>



<b>Selection</b>	<b>Setting</b> <i>* Indicates default</i>	<b>Serial Command</b> <i># Indicates a numeric entry</i>	<b>Page</b>
Keyboard Modifiers	*Control + ASCII Off	KBDCAS0	<a href="#">2-18</a>
	DOS Mode Control + ASCII	KBDCAS1	<a href="#">2-18</a>
	Windows Mode Control + ASCII	KBDCAS2	<a href="#">2-18</a>
	Windows Mode Prefix/Suffix Off	KBDCAS3	<a href="#">2-18</a>
	*Turbo Mode Off	KBDTMD0	<a href="#">2-19</a>
	Turbo Mode On	KBDTMD1	<a href="#">2-19</a>
	*Numeric Keypad Off	KBDNPS0	<a href="#">2-19</a>
	Numeric Keypad On	KBDNPS1	<a href="#">2-19</a>
	*Auto Direct Connect Off	KBDADC0	<a href="#">2-19</a>
	Auto Direct Connect On	KBDADC1	<a href="#">2-19</a>
Baud Rate	300 BPS	232BAD0	<a href="#">2-20</a>
	600 BPS	232BAD1	<a href="#">2-20</a>
	1200 BPS	232BAD2	<a href="#">2-20</a>
	2400 BPS	232BAD3	<a href="#">2-20</a>
	4800 BPS	232BAD4	<a href="#">2-20</a>
	*9600 BPS	232BAD5	<a href="#">2-20</a>
	19200 BPS	232BAD6	<a href="#">2-20</a>
	38400 BPS	232BAD7	<a href="#">2-20</a>
	57600 BPS	232BAD8	<a href="#">2-20</a>
	115200 BPS	232BAD9	<a href="#">2-20</a>

<b>Selection</b>	<b>Setting</b> <i>* Indicates default</i>	<b>Serial Command</b> <i># Indicates a numeric entry</i>	<b>Page</b>
Word Length: Data Bits, Stop Bits, and Parity	7 Data, 1 Stop, Parity Even	232WRD3	<a href="#">2-21</a>
	7 Data, 1 Stop, Parity None	232WRD0	<a href="#">2-21</a>
	7 Data, 1 Stop, Parity Odd	232WRD6	<a href="#">2-21</a>
	7 Data, 2 Stop, Parity Even	232WRD4	<a href="#">2-21</a>
	7 Data, 2 Stop, Parity None	232WRD1	<a href="#">2-21</a>
	7 Data, 2 Stop, Parity Odd	232WRD7	<a href="#">2-21</a>
	8 Data, 1 Stop, Parity Even	232WRD5	<a href="#">2-21</a>
	*8 Data, 1 Stop, Parity None	232WRD2	<a href="#">2-21</a>
	8 Data, 1 Stop, Parity Odd	232WRD8	<a href="#">2-21</a>
RS232 Receiver Time-out	Range 0 - 300 seconds	232LPT###	<a href="#">2-22</a>
RS232 Handshaking	*RTS/CTS Off	232CTS0	<a href="#">2-22</a>
	Flow Control, No Timeout	232CTS1	<a href="#">2-22</a>
	Two-Direction Flow Control	232CTS2	<a href="#">2-22</a>
	Flow Control with Timeout	232CTS3	<a href="#">2-22</a>
	RS232 Timeout	232DEL####	<a href="#">2-23</a>
	*XON/XOFF Off	232XON0	<a href="#">2-23</a>
	XON/XOFF On	232XON1	<a href="#">2-23</a>
	*ACK/NAK Off	232ACK0	<a href="#">2-24</a>
	ACK/NAK On	232ACK1	<a href="#">2-24</a>
Scanner-Biopic Packet Mode	*Packet Mode Off	232PKT0	<a href="#">2-24</a>
	Packet Mode On	232PKT2	<a href="#">2-3</a>

<b>Selection</b>	<b>Setting</b> <i>* Indicates default</i>	<b>Serial Command</b> <i># Indicates a numeric entry</i>	<b>Page</b>
Scanner-Bioptic ACK/NAK Mode	*Bioptic ACK/NAK Off	232NAK0	<a href="#">2-25</a>
	Bioptic ACK/NAK On	232NAK1	<a href="#">2-25</a>
Scanner-Bioptic ACK/NAK Timeout	ACK/NAK Timeout *5100	232DLK#####	<a href="#">2-25</a>
<b><i>Cordless System Operation</i></b>			
<i>Note: This section applies only to cordless systems. It does not apply to corded scanners.</i>			
Base Power Communication Indicator	*On	:.:BASRED1	<a href="#">3-8</a>
	Off	:.:BASRED0	<a href="#">3-8</a>
Reset Scanner	Reset Scanner	RESET_	<a href="#">3-8</a>
Scanning While in Base Cradle	Scanning in Cradle Off	BT_SIC0	<a href="#">3-9</a>
	*Scanning in Cradle On	BT_SIC1	<a href="#">3-9</a>
	Shut Down Scanner in Cradle	BT_SIC2	<a href="#">3-9</a>
Paging Mode	*On	BEPPGE1	<a href="#">3-9</a>
	Off	BEPPGE0	<a href="#">3-9</a>
Paging Pitch	Range 400 - 9000 Hz (*1000)	BEPPFQ#####	<a href="#">3-9</a>
Beeper Pitch - Base Error	*Razz (250) (min 200Hz)	BASFQ2250	<a href="#">3-10</a>
	Medium (3250)	BASFQ23250	<a href="#">3-10</a>
	High (4200) (max 9000Hz)	BASFQ24200	<a href="#">3-10</a>
Number of Beeps - Base Error	*1	BASERR3	<a href="#">3-11</a>
	Range 1 - 9	BASERR#	<a href="#">3-11</a>
Scanner Report	Scanner Report	RPTSCN	<a href="#">3-11</a>
Scanner Address	Scanner Address	BT_LDA	<a href="#">3-11</a>
Base Address	Base Address	:.:BASLDA	<a href="#">3-11</a>

<b>Selection</b>	<b>Setting</b> <i>* Indicates default</i>	<b>Serial Command</b> <i># Indicates a numeric entry</i>	<b>Page</b>
Scanner Modes	Charge Only Mode	::*:BASLNK0	<a href="#">3-12</a>
	*Charge and Link Mode	::*:BASLNK1	<a href="#">3-12</a>
	Locked Link Mode	BASCON0,DNG1	<a href="#">3-13</a>
	*Open Link Mode	BASCON1,DNG1	<a href="#">3-13</a>
	Unlink Scanner	BT_RMV	<a href="#">3-13</a>
	Override Locked Scanner	BT_RPL1	<a href="#">3-14</a>
Out-of-Range Alarm	Base Alarm Duration (Range 1 - 3000 sec (*0))	BASORD	<a href="#">3-14</a>
	Scanner Alarm Duration (Range 1 - 3000 sec (*0))	BT_ORD	<a href="#">3-14</a>
Alarm Sound Type	Base Alarm Type	BASORW	<a href="#">3-15</a>
	Scanner Alarm Type	BT_ORW	<a href="#">3-15</a>
Scanner Power Time-Out Timer	Timer (0-7200 seconds)	BT_LPT0	<a href="#">3-16</a>
	200 Seconds	BT_LPT200	<a href="#">3-16</a>
	400 Seconds	BT_LPT400	<a href="#">3-16</a>
	900 Seconds	BT_LPT900	<a href="#">3-16</a>
	3600 Seconds	BT_LPT3600	<a href="#">3-16</a>
	7200 Seconds	BT_LPT7200	<a href="#">3-16</a>
Flexible Power Management	*Full Power	BT_TXP100	<a href="#">3-17</a>
	Medium Power	BT_TXP35	<a href="#">3-17</a>
	Medium Low Power	BT_TXP5	<a href="#">3-17</a>
	Low Power	BT_TXP1	<a href="#">3-17</a>
Reset	Reset Base	RESET_	<a href="#">3-18</a>
	Reset Scanner	::*:RESET_	<a href="#">3-18</a>

<b>Selection</b>	<b>Setting</b> <i>* Indicates default</i>	<b>Serial Command</b> <i># Indicates a numeric entry</i>	<b>Page</b>
Batch Mode	Automatic Batch Mode	BATENA1	<a href="#">3-19</a>
	*Batch Mode Off	BATENA0	<a href="#">3-19</a>
	Inventory Batch Mode	BATENA2	<a href="#">3-19</a>
Batch Mode Beep	Off	BATBEP0	<a href="#">3-19</a>
	*On	BATBEP1	<a href="#">3-19</a>
Batch Mode Storage	*Flash Storage	BATNVS1	<a href="#">3-20</a>
	RAM Storage	BATNVS0	<a href="#">3-20</a>
Batch Mode Quantity	*Off	BATQTY0	<a href="#">3-20</a>
	On	BATQTY1	<a href="#">3-20</a>
Quantity Codes	0	BATNUM0	<a href="#">3-22</a>
	*1	BATNUM1	<a href="#">3-22</a>
	2	BATNUM2	<a href="#">3-22</a>
	3	BATNUM3	<a href="#">3-22</a>
	4	BATNUM4	<a href="#">3-22</a>
	5	BATNUM5	<a href="#">3-22</a>
	6	BATNUM6	<a href="#">3-22</a>
	7	BATNUM7	<a href="#">3-22</a>
	8	BATNUM8	<a href="#">3-22</a>
9	BATNUM9	<a href="#">3-22</a>	
Batch Mode Output Order	*FIFO	BATLIF0	<a href="#">3-23</a>
	LIFO	BATLIF1	<a href="#">3-23</a>
Total Records	Total Records	BATNRC	<a href="#">3-23</a>
Delete Last Code	Delete Last Code	BATUND	<a href="#">3-23</a>
Clear All Codes	Clear All Codes	BATCLR	<a href="#">3-23</a>
Transmit Records to Host	Transmit Inventory Records	BAT_TX	<a href="#">3-24</a>
Batch Mode Transmit Delay	*Off	BATDLY0	<a href="#">3-24</a>
	Short (ms)	BATDLY250	<a href="#">3-24</a>
	Medium (ms)	BATDLY500	<a href="#">3-24</a>
	Long (ms)	BATDLY1000	<a href="#">3-24</a>

<b>Selection</b>	<b>Setting</b> <i>* Indicates default</i>	<b>Serial Command</b> <i># Indicates a numeric entry</i>	<b>Page</b>
Multiple Scanner Operation	Multiple Scanner Operation	BASCON2,DNG3	<a href="#">3-25</a>
Scanner Name	Name 1-7	BT_NAM#####	<a href="#">3-26</a>
	Reset	RESET_	<a href="#">3-26</a>
	Scanner Name	BT_NAM	<a href="#">3-26</a>
Application Work Group Selections	*Group 0	GRPSELO	<a href="#">3-28</a>
	Group 1-6	GRPSEL#	<a href="#">3-28</a>
Resetting the Factory Defaults: All Application Work Groups	Factory Default Settings: All Work Groups	PAPDFT&	<a href="#">3-28</a>
Resetting the Custom Defaults: All Application Work Groups	Custom Default Settings: All Work Groups	PAPDFT	<a href="#">3-29</a>
Bluetooth Connection	Bluetooth HID Keyboard Connect	PAPBTH	<a href="#">3-30</a>
	Bluetooth HID Keyboard Disconnect	PAPSPP	<a href="#">3-32</a>
	Bluetooth Serial Port - PCs/Laptops	BT_TRM0;BT_DN G5	<a href="#">3-32</a>
	BT Connection - PDA/Mobility Systems Device	BT_TRM0;BT_DN G1	<a href="#">3-32</a>
	Bluetooth PIN Code	BT_PIN	<a href="#">3-33</a>
Bluetooth PIN Code	Bluetooth PIN	BT_PIN	<a href="#">3-33</a>
	Auto Reconnect Mode	*Auto Reconnect On	<a href="#">3-33</a>
	Auto Reconnect Off	BT_ACM0	<a href="#">3-33</a>
Maximum Link Attempts	Maximum Link Attempts	BT_MLA	<a href="#">3-35</a>
Relink Time-Out	Relink Time-Out	BT_RLT	<a href="#">3-35</a>
Host Command Acknowledgment	Host ACK On	HSTACK1	<a href="#">3-38</a>
	*Host ACK Off	HSTACK0	<a href="#">3-38</a>

<b>Selection</b>	<b>Setting</b> <i>* Indicates default</i>	<b>Serial Command</b> <i># Indicates a numeric entry</i>	<b>Page</b>
<b><i>Input/Output Selections</i></b>			
Power Up Beeper	Power Up Beeper Off - Scanner	BEP PWR0	4-1
	*Power Up Beeper On - Scanner	BEP PWR1	4-1
	Power Up Beeper Off - Cordless Base	BASPWR0	4-1
	Power Up Beeper On - Cordless Base	BASPWR1	4-1
Beep on BEL Character	Beep on BEL On	BELBEP1	4-1
	*Beep on BEL Off	BELBEP0	4-1
Trigger Click	On	BEPTRG1	4-2
	*Off	BEPTRG0	4-2
Beeper - Good Read	Off	BEPBEP0	4-3
	*On	BEPBEP1	4-2
Beeper Volume - Good Read	Off	BEPLVL0	4-2
	Low	BEPLVL1	4-3
	Medium	BEPLVL2	4-3
	*High	BEPLVL3	4-3
Beeper Pitch - Good Read (Frequency)	Low (1600) (min 400Hz)	BEPFQ11600	4-3
	*Medium 2700)	BEPFQ12700	4-3
	High (4200) (max 9000Hz)	BEPFQ14200	4-3
Beeper Pitch - Error (Frequency)	*Razz (250) (min 200Hz)	BEPFQ2800	4-4
	Medium (3250)	BEPFQ23250	4-4
	High (4200) (max 9000Hz)	BEPFQ24200	4-4
Beeper Duration - Good Read	*Normal Beep	BEPBIP0	4-4
	Short Beep	BEPBIP1	4-4
LED - Good Read	Off	BEPLED0	4-4
	*On	BEPLED1	4-4

<b>Selection</b>	<b>Setting</b> <i>* Indicates default</i>	<b>Serial Command</b> <i># Indicates a numeric entry</i>	<b>Page</b>
Number of Beeps - Error	*1	BEPERR3	4-5
	Range 1 - 9	BEPERR#	4-5
Number of Beeps - Good Read	*1	BEPRPT1	4-5
	Range 1 - 9	BEPRPT#	4-5
Good Read Delay	*No Delay	DLYGRD0	4-6
	Short Delay (500 ms)	DLYGRD500	4-6
	Medium Delay (1000 ms)	DLYGRD1000	4-6
	Long Delay (1500 ms)	DLYGRD1500	4-6
User-Specified Good Read Delay	Range 0 - 30,000 ms	DLYGRD#####	4-6
Manual Trigger Modes	*Manual Trigger - Normal	PAPHHF	4-7
	Manual Trigger - Enhanced	PAPHHS	4-7
LED Illumination - Manual Trigger	Off	PWRNOL0	4-7
	Low	PWRNOL100	4-7
	*High	PWRNOL150	4-7
Serial Trigger Mode	Read Time-Out (0 - 300,000 ms) *30,000	TRGSTO#####	4-7
Presentation	Presentation Mode	TRGMOD3	4-8
LED Illumination - Presentation Mode	Off	PWRLDC0	4-9
	Low	PWRLDC100	4-9
	*High	PWRLDC150	4-9
Presentation LED Behavior After Decode	*LEDs On	TRGPCK1	4-9
	LEDs Off	TRGPCK0	4-9
Presentation Sensitivity	Range 0-20 (*1)	TRGPMS##	4-10



<b>Selection</b>	<b>Setting</b> <i>* Indicates default</i>	<b>Serial Command</b> <i># Indicates a numeric entry</i>	<b>Page</b>
Presentation Centering Window	Presentation Centering On	PDCWIN1	<a href="#">4-12</a>
	*Presentation Centering Off	PDCWIN0	<a href="#">4-12</a>
	Left of Presentation Centering Window (*40%)	PDCLFT###	<a href="#">4-12</a>
	Right of Presentation Centering Window (*60%)	PDCRGT###	<a href="#">4-12</a>
	Top of Presentation Centering Window (*40%)	PDCTOP###	<a href="#">4-12</a>
	Bottom of Presentation Centering Window (*60%)	PDCBOT###	<a href="#">4-12</a>
In-Stand Sensor Mode	Sensor On	TRGSSW1	<a href="#">4-12</a>
	Sensor Off	TRGSSW0	<a href="#">4-12</a>
CodeGate	*CodeGate Off Out-of-Stand	AOSCGD0.	<a href="#">4-13</a>
	CodeGate On Out-of-Stand	AOSCGD1.	<a href="#">4-13</a>
Streaming Presentation	Streaming Presentation Mode - Normal	PAPSPN	<a href="#">4-13</a>
	Streaming Presentation Mode - Enhanced	PAPSPE	<a href="#">4-13</a>
Mobile Phone Read Mode	Hand Held Scanning - Mobile Phone	PAPPHC	<a href="#">4-14</a>
	Streaming Presentation - Mobile Phone	PAPSPC	<a href="#">4-14</a>

<b>Selection</b>	<b>Setting</b> <i>* Indicates default</i>	<b>Serial Command</b> <i># Indicates a numeric entry</i>	<b>Page</b>
Image Snap and Ship	Image Snap and Ship	TRGMOD6	4-15
Hands Free Time-Out	Range 0 - 300,000 ms	TRGPTO#####	4-15
Reread Delay	Short (500 ms)	DLYRRD500	4-16
	*Medium (750 ms)	DLYRRD750	4-16
	Long (1000 ms)	DLYRRD1000	4-16
	Extra Long (2000 ms)	DLYRRD2000	4-15
User-Specified Reread Delay	Range 0 - 30,000 ms	DLYRRD#####	4-16
Illumination Lights	*Lights On	SCNLED1	4-16
	Lights Off	SCNLED0	4-16
Aimer Delay	200 milliseconds	SCNDLY200	4-17
	400 milliseconds	SCNDLY400	4-17
	*Off (no delay)	SCNDLY0	4-17
User-Specified Aimer Delay	Range 0 - 4,000 ms	SCNDLY####	4-17
Scanner Time-Out	0 - 999,999 ms	SDRTIM####	4-17
Aimer Mode	Off	SCNAIM0	4-18
	*Interlaced	SCNAIM2	4-18
Centering Window	Centering On	DECWIN1	4-20
	*Centering Off	DECWIN0	4-20
	Left of Centering Window (*40%)	DECLFT###	4-20
	Right of Centering Window (*60%)	DECRGT###	4-20
	Top of Centering Window (*40%)	DECTOP###	4-20
	Bottom of Centering Window (*60%)	DECBOT###	4-20

<b>Selection</b>	<b>Setting</b> <i>* Indicates default</i>	<b>Serial Command</b> <i># Indicates a numeric entry</i>	<b>Page</b>
Preferred Symbology	On	PRFENA1	4-21
	*Off	PRFENA0	4-21
	High Priority Symbology	PRFCOD##	4-21
	Low Priority Symbology	PRFBLK##	4-21
	Preferred Symbology Timeout (*500) Range 100-3000	PRFP TO####	4-22
	Preferred Symbology Default	PRFDFT	4-22
Output Sequence Editor	Enter Sequence	SEQBLK	4-25
	Default Sequence	SEQDFT	4-25
Partial Sequence	Transmit Partial Sequence	SEQTTS1	4-25
	*Discard Partial Sequence	SEQTTS0	4-25
Require Output Sequence	Required	SEQ_EN2	4-26
	On/Not Required	SEQ_EN1	4-26
	*Off	SEQ_EN0	4-26
Multiple Symbols	On	SHOTGN1	4-26
	*Off	SHOTGN0	4-26
No Read	On	SHWNRD1	4-27
	*Off	SHWNRD0	4-27
Video Reverse	Video Reverse Only	VIDREV1	4-27
	Video Reverse and Standard Bar Codes	VIDREV2	4-27
	*Video Reverse Off	VIDREV0	4-27

<b>Selection</b>	<b>Setting</b> <i>* Indicates default</i>	<b>Serial Command</b> <i># Indicates a numeric entry</i>	<b>Page</b>
Working Orientation	*Upright	ROTATN0	4-28
	Vertical, Bottom to Top (Rotate CCW 90°)	ROTATN1	4-28
	Upside Down	ROTATN2	4-28
	Vertical, Top to Bottom (Rotate CW 90°)	ROTATN3	4-28
<b>Prefix/Suffix Selections</b>			
Add CR Suffix to All Symbolologies		VSUFRCR	5-3
Prefix	Add Prefix	PREBK2##	5-3
	Clear One Prefix	PRECL2	5-3
	Clear All Prefixes	PRECA2	5-3
Suffix	Add Suffix	SUFBK2##	5-4
	Clear One Suffix	SUFCL2	5-4
	Clear All Suffixes	SUFCA2	5-4
Function Code Transmit	*Enable	RMVFNC0	5-4
	Disable	RMVFNC1	5-4
Intercharacter Delay	Range 0 - 1000 (5ms increments)	DLYCHR##	5-5
User Specified Intercharacter Delay	Delay Length 0 - 1000 (5ms increments)	DLYCRX##	5-5
	Character to Trigger Delay	DLY_XX##	5-5
Interfunction Delay	Range 0 - 1000 (5ms increments)	DLYFNC##	5-6
Intermessage Delay	Range 0 - 1000 (5ms increments)	DLYMSG##	5-6

<b>Selection</b>	<b>Setting</b> <i>* Indicates default</i>	<b>Serial Command</b> <i># Indicates a numeric entry</i>	<b>Page</b>
<b>Data Formatter Selections</b>			
Data Format Editor	*Default Data Format (None)	DFMDF3	6-1
	Enter Data Format	DFMBK3##	6-2
	Clear One Data Format	DFMCL3	6-3
	Clear All Data Formats	DFMCA3	6-3
Data Formatter	Data Formatter Off	DFM_EN0	6-9
	*Data Formatter On, Not Required, Keep Prefix/Suffix	DFM_EN1	6-10
	Data Format Required, Keep Prefix/Suffix	DFM_EN2	6-10
	Data Formatter On, Not Required, Drop Prefix/Suffix	DFM_EN3	6-10
	Data Format Required, Drop Prefix/Suffix	DFM_EN4	6-10
Data Format Non-Match Error Tone	*Data Format Non-Match Error Tone On	DFMDEC0	6-11
	Data Format Non-Match Error Tone Off	DFMDEC1	6-11
Primary/Alternate Data Formats	Primary Data Format	ALTFNM0	6-11
	Data Format 1	ALTFNM1	6-11
	Data Format 2	ALTFNM2	6-11
	Data Format 3	ALTFNM3	6-11

<b>Selection</b>	<b>Setting</b> <i>* Indicates default</i>	<b>Serial Command</b> <i># Indicates a numeric entry</i>	<b>Page</b>
Single Scan Data Format Change	Single Scan-Primary Data Format	VSAF_0	<a href="#">6-12</a>
	Single Scan-Data Format 1	VSAF_1	<a href="#">6-12</a>
	Single Scan-Data Format 2	VSAF_2	<a href="#">6-12</a>
	Single Scan-Data Format 3	VSAF_3	<a href="#">6-12</a>
<b><i>Symbologies</i></b>			
All Symbologies	All Symbologies Off	ALLENA0	<a href="#">7-2</a>
	All Symbologies On	ALLENA1	<a href="#">7-2</a>
Codabar	Default All Codabar Settings	CBRDFT	<a href="#">7-3</a>
	Off	CBRENA0	<a href="#">7-3</a>
	*On	CBRENA1	<a href="#">7-3</a>
Codabar Start/Stop Char.	*Don't Transmit	CBRSSX0	<a href="#">7-3</a>
	Transmit	CBRSSX1	<a href="#">7-3</a>
Codabar Check Char.	*No Check Char.	CBRCK20	<a href="#">7-4</a>
	Validate, But Don't Transmit	CBRCK21	<a href="#">7-4</a>
	Validate, and Transmit	CBRCK22	<a href="#">7-4</a>
Codabar Concatenation	*Off	CBRCCT0	<a href="#">7-4</a>
	On	CBRCCT1	<a href="#">7-4</a>
	Require	CBRCCT2	<a href="#">7-4</a>
Codabar Message Length	Minimum (2 - 60) *4	CBRMIN##	<a href="#">7-5</a>
	Maximum (2 - 60) *60	CBRMAX##	<a href="#">7-5</a>
Code 39	Default All Code 39 Settings	C39DFT	<a href="#">7-6</a>
	Off	C39ENA0	<a href="#">7-6</a>
	*On	C39ENA1	<a href="#">7-6</a>

<b>Selection</b>	<b>Setting</b> <i>* Indicates default</i>	<b>Serial Command</b> <i># Indicates a numeric entry</i>	<b>Page</b>
Code 39 Start/Stop Char.	*Don't Transmit	C39SSX0	<a href="#">7-6</a>
	Transmit	C39SSX1	<a href="#">7-6</a>
Code 39 Check Char.	*No Check Char.	C39CK20	<a href="#">7-7</a>
	Validate, But Don't Transmit	C39CK21	<a href="#">7-7</a>
	Validate, and Transmit	C39CK22	<a href="#">7-7</a>
Code 39 Message Length	Minimum (0 - 48) *0	C39MIN##	<a href="#">7-7</a>
	Maximum (0 - 48) *48	C39MAX##	<a href="#">7-7</a>
Code 39 Append	*Off	C39APP0	<a href="#">7-8</a>
	On	C39APP1	<a href="#">7-8</a>
Code 32 Pharmaceutical (PARAF)	*Off	C39B320	<a href="#">7-8</a>
	On	C39B321	<a href="#">7-8</a>
Code 39 Full ASCII	*Off	C39ASC0	<a href="#">7-9</a>
	On	C39ASC1	<a href="#">7-9</a>
	Code 39 Code Page	C39DCP	<a href="#">7-10</a>
Interleaved 2 of 5	Default All Interleaved 2 of 5 Settings	I25DFT	<a href="#">7-10</a>
	Off	I25ENA0	<a href="#">7-10</a>
	*On	I25ENA1	<a href="#">7-10</a>
Interleaved 2 of 5 Check Digit	*No Check Char.	I25CK20	<a href="#">7-11</a>
	Validate, But Don't Transmit	I25CK21	<a href="#">7-11</a>
	Validate, and Transmit	I25CK22	<a href="#">7-11</a>
Interleaved 2 of 5 Message Length	Minimum (2 - 80) *4	I25MIN##	<a href="#">7-11</a>
	Maximum (2 - 80) *80	I25MAX##	<a href="#">7-11</a>

<b>Selection</b>	<b>Setting</b> <i>* Indicates default</i>	<b>Serial Command</b> <i># Indicates a numeric entry</i>	<b>Page</b>
NEC 2 of 5	Default All NEC 2 of 5 Settings	N25DFT	<a href="#">7-12</a>
	Off	N25ENA0	<a href="#">7-12</a>
	*On	N25ENA1	<a href="#">7-12</a>
NEC 2 of 5 Check Digit	*No Check Char.	N25CK20	<a href="#">7-12</a>
	Validate, But Don't Transmit	N25CK21	<a href="#">7-12</a>
	Validate, and Transmit	N25CK22	<a href="#">7-12</a>
NEC 2 of 5 Message Length	Minimum (2 - 80) *4	N25MIN##	<a href="#">7-13</a>
	Maximum (2 - 80) *80	N25MAX##	<a href="#">7-13</a>
Code 93	Default All Code 93 Settings	C93DFT	<a href="#">7-14</a>
	Off	C93ENA0	<a href="#">7-14</a>
	*On	C93ENA1	<a href="#">7-16</a>
Code 93 Message Length	Minimum (0 - 80) *0	C93MIN##	<a href="#">7-14</a>
	Maximum (0 - 80) *80	C93MAX##	<a href="#">7-14</a>
Code 93 Append	On	C93APP1	<a href="#">7-15</a>
	*Off	C93APP0	<a href="#">7-15</a>
Code 93 Code Page	Code 93 Code Page	C93DCP	<a href="#">7-15</a>
Straight 2 of 5 Industrial	Default All Straight 2 of 5 Industrial Settings	R25DFT	<a href="#">7-16</a>
	*Off	R25ENA0	<a href="#">7-16</a>
	On	R25ENA1	<a href="#">7-16</a>
Straight 2 of 5 Industrial Message Length	Minimum (1 - 48) *4	R25MIN##	<a href="#">7-16</a>
	Maximum (1 - 48) *48	R25MAX##	<a href="#">7-16</a>
Straight 2 of 5 IATA	Default All Straight 2 of 5 IATA Settings	A25DFT	<a href="#">7-17</a>



<b>Selection</b>	<b>Setting</b> <i>* Indicates default</i>	<b>Serial Command</b> <i># Indicates a numeric entry</i>	<b>Page</b>
Straight 2 of 5 IATA	*Off	A25ENA0	7-17
	On	A25ENA1	7-17
Straight 2 of 5 IATA Message Length	Minimum (1 - 48) *4	A25MIN##	7-17
	Maximum (1 - 48) *48	A25MAX##	7-17
Matrix 2 of 5	Default All Matrix 2 of 5 Settings	X25DFT	7-18
	*Off	X25ENA0	7-18
	On	X25ENA1	7-18
Matrix 2 of 5 Message Length	Minimum (1 - 80) *4	X25MIN##	7-18
	Maximum (1 - 80) *80	X25MAX##	7-18
Code 11	Default All Code 11 Settings	C11DFT	7-19
	*Off	C11ENA0	7-19
	On	C11ENA1	7-19
Code 11 Check Digits Required	1 Check Digit	C11CK20	7-19
	*2 Check Digits	C11CK21	7-19
Code 11 Message Length	Minimum (1 - 80) *4	C11MIN##	7-20
	Maximum (1 - 80) *80	C11MAX##	7-20
Code 128	Default All Code 128 Settings	128DFT	7-20
	Off	128ENA0	7-20
	*On	128ENA1	7-20
ISBT Concatenation	*Off	ISBENA0	7-21
	On	ISBENA1	7-21
Code 128 Message Length	Minimum (0 - 80) *0	128MIN##	7-21
	Maximum (0 - 80) *80	128MAX##	7-21
Code 128 Append	On	128APP1	7-21
	*Off	128APP0	7-21

<b>Selection</b>	<b>Setting</b> <i>* Indicates default</i>	<b>Serial Command</b> <i># Indicates a numeric entry</i>	<b>Page</b>
Code 128 Code Page	Code 128 Code Page (*2)	128DCP##	<a href="#">7-22</a>
GS1-128	Default All GS1-128 Settings	GS1DFT	<a href="#">7-23</a>
	*On	GS1ENA1	<a href="#">7-23</a>
	Off	GS1ENA0	<a href="#">7-23</a>
GS1-128 Message Length	Minimum (1 - 80) *1	GS1MIN	<a href="#">7-23</a>
	Maximum (0 - 80) *80	GS1MAX	<a href="#">7-23</a>
Telepen	Default All Telepen Settings	TELDFT	<a href="#">7-24</a>
	*Off	TELENA0	<a href="#">7-24</a>
	On	TELENA1	<a href="#">7-24</a>
Telepen Output	*AIM Telepen Output	TELOLD0	<a href="#">7-24</a>
	Original Telepen Output	TELOLD1	<a href="#">7-24</a>
Telepen Message Length	Minimum (1 - 60) *1	TELMIN##	<a href="#">7-25</a>
	Maximum (1 - 60) *60	TELMAX##	<a href="#">7-25</a>
UPC-A	Default All UPC-A Settings	UPADFT	<a href="#">7-25</a>
	Off	UPAENA0	<a href="#">7-25</a>
	*On	UPAENA1	<a href="#">7-25</a>
UPC-A Check Digit	Off	UPACKX0	<a href="#">7-25</a>
	*On	UPACKX1	<a href="#">7-25</a>
UPC-A Number System	Off	UPANSX0	<a href="#">7-26</a>
	*On	UPANSX1	<a href="#">7-26</a>
UPC-A 2 Digit Addenda	*Off	UPAAD20	<a href="#">7-26</a>
	On	UPAAD21	<a href="#">7-26</a>
UPC-A 5 Digit Addenda	*Off	UPAAD50	<a href="#">7-26</a>
	On	UPAAD51	<a href="#">7-26</a>
UPC-A Addenda Required	*Not Required	UPAARQ0	<a href="#">7-26</a>
	Required	UPAARQ1	<a href="#">7-26</a>

<b>Selection</b>	<b>Setting</b> <i>* Indicates default</i>	<b>Serial Command</b> <i># Indicates a numeric entry</i>	<b>Page</b>
UPC-A Addenda Separator	Off	UPAADS0	<a href="#">7-27</a>
	*On	UPAADS1	<a href="#">7-27</a>
UPC-A/EAN-13 with Extended Coupon Code	*Off	CPNENA0	<a href="#">7-27</a>
	Allow Concatenation	CPNENA1	<a href="#">7-27</a>
	Require Concatenation	CPNENA2	<a href="#">7-27</a>
Coupon GS1 DataBar Output	GS1 Output Off	CPNGS10	<a href="#">7-28</a>
	GS1 Output On	CPNGS11	<a href="#">7-28</a>
UPC-E0	Default All UPC-E Settings	UPEDFT	<a href="#">7-28</a>
	Off	UPEEN00	<a href="#">7-28</a>
	*On	UPEEN01	<a href="#">7-28</a>
UPC-E0 Expand	*Off	UPEEXP0	<a href="#">7-29</a>
	On	UPEEXP1	<a href="#">7-29</a>
UPC-E0 Addenda Required	Required	UPEARQ1	<a href="#">7-29</a>
	*Not Required	UPEARQ0	<a href="#">7-29</a>
UPC-E0 Addenda Separator	*On	UPEADS1	<a href="#">7-29</a>
	Off	UPEADS0	<a href="#">7-29</a>
UPC-E0 Check Digit	Off	UPECKX0	<a href="#">7-30</a>
	*On	UPECKX1	<a href="#">7-30</a>
UPC-E0 Number System	Off	UPENSX0	<a href="#">7-30</a>
	*On	UPENSX1	<a href="#">7-30</a>
UPC-E0 Addenda	2 Digit Addenda On	UPEAD21	<a href="#">7-30</a>
	*2 Digit Addenda Off	UPEAD20	<a href="#">7-30</a>
	5 Digit Addenda On	UPEAD51	<a href="#">7-30</a>
	*5 Digit Addenda Off	UPEAD50	<a href="#">7-30</a>
UPC-E1	*Off	UPEEN10	<a href="#">7-31</a>
	On	UPEEN11	<a href="#">7-31</a>
EAN/JAN-13	Default All EAN/JAN Settings	E13DFT	<a href="#">7-31</a>
	Off	E13ENA0	<a href="#">7-31</a>
	*On	E13ENA1	<a href="#">7-31</a>

<b>Selection</b>	<b>Setting</b> <i>* Indicates default</i>	<b>Serial Command</b> <i># Indicates a numeric entry</i>	<b>Page</b>
EAN/JAN-13 Check Digit	Off	E13CKX0	<a href="#">7-31</a>
	*On	E13CKX1	<a href="#">7-31</a>
EAN/JAN-13 2 Digit Addenda	2 Digit Addenda On	E13AD21	<a href="#">7-32</a>
	*2 Digit Addenda Off	E13AD20	<a href="#">7-32</a>
	5 Digit Addenda On	E13AD51	<a href="#">7-32</a>
	*5 Digit Addenda Off	E13AD50	<a href="#">7-32</a>
EAN/JAN-13 Addenda Required	*Not Required	E13ARQ0	<a href="#">7-32</a>
	Required	E13ARQ1	<a href="#">7-32</a>
EAN/JAN-13 Addenda Separator	Off	E13ADS0	<a href="#">7-33</a>
	*On	E13ADS1	<a href="#">7-33</a>
ISBN Translate	*Off	E13ISB0	<a href="#">7-33</a>
	On	E13ISB1	<a href="#">7-33</a>
EAN/JAN-8	Default All EAN/ JAN 8 Settings	EA8DFT	<a href="#">7-34</a>
	Off	EA8ENA0	<a href="#">7-34</a>
	*On	EA8ENA1	<a href="#">7-34</a>
EAN/JAN-8 Check Digit	Off	EA8CKX0	<a href="#">7-34</a>
	*On	EA8CKX1	<a href="#">7-34</a>
EAN/JAN-8 Addenda	*2 Digit Addenda Off	EA8AD20	<a href="#">7-35</a>
	2 Digit Addenda On	EA8AD21	<a href="#">7-35</a>
	*5 Digit Addenda Off	EA8AD50	<a href="#">7-35</a>
	5 Digit Addenda On	EA8AD51	<a href="#">7-35</a>
EAN/JAN-8 Addenda Required	*Not Required	EA8ARQ0	<a href="#">7-35</a>
	Required	EA8ARQ1	<a href="#">7-35</a>
EAN/JAN-8 Addenda Separator	Off	EA8ADS0	<a href="#">7-35</a>
	*On	EA8ADS1	<a href="#">7-35</a>
MSI	Default All MSI Settings	MSIDFT	<a href="#">7-36</a>
	*Off	MSIENA0	<a href="#">7-36</a>
	On	MSIENA1	<a href="#">7-36</a>

<b>Selection</b>	<b>Setting</b> <i>* Indicates default</i>	<b>Serial Command</b> <i># Indicates a numeric entry</i>	<b>Page</b>
MSI Check Character	*Validate Type 10, but Don't Transmit	MSICLK0	<a href="#">7-37</a>
	Validate Type 10 and Transmit	MSICLK1	<a href="#">7-37</a>
	Validate 2 Type 10 Chars, but Don't Transmit	MSICLK2	<a href="#">7-37</a>
	Validate 2 Type 10 Chars and Transmit	MSICLK3	<a href="#">7-37</a>
	Validate Type 10 then Type 11 Char, but Don't Transmit	MSICLK4	<a href="#">7-37</a>
	Validate Type 10 then Type 11 Char and Transmit	MSICLK5	<a href="#">7-37</a>
	Disable MSI Check Characters	MSICLK6	<a href="#">7-37</a>
MSI Message Length	Minimum (4 - 48) *4	MSIMIN##	<a href="#">7-37</a>
	Maximum (4 - 48) *48	MSIMAX##	<a href="#">7-37</a>
GS1 DataBar Omnidirectional	Default All GS1 DataBar Omnidirectional Settings	RSSDFT	<a href="#">7-38</a>
	Off	RSSENA0	<a href="#">7-38</a>
	*On	RSSENA1	<a href="#">7-38</a>
GS1 DataBar Limited	Default All GS1 DataBar Limited Settings	RSLDFT	<a href="#">7-38</a>
	Off	RSLENA0	<a href="#">7-38</a>
	*On	RSLENA1	<a href="#">7-38</a>

<b>Selection</b>	<b>Setting</b> <i>* Indicates default</i>	<b>Serial Command</b> <i># Indicates a numeric entry</i>	<b>Page</b>
GS1 DataBar Expanded	Default All GS1 DataBar Expanded Settings	RSEDFT	<a href="#">7-39</a>
	Off	RSEENA0	<a href="#">7-39</a>
	*On	RSEENA1	<a href="#">7-39</a>
GS1 DataBar Expanded Msg. Length	Minimum (4 - 74) *4	RSEMIN##	<a href="#">7-39</a>
	Maximum (4 - 74) *74	RSEMAX##	<a href="#">7-39</a>
Trioptic Code	*Off	TRIENA0	<a href="#">7-40</a>
	On	TRIENA1	<a href="#">7-40</a>
Codablock A	Default All Codablock A Settings	CBADFT	<a href="#">7-40</a>
	*Off	CBAENA0	<a href="#">7-40</a>
	On	CBAENA1	<a href="#">7-40</a>
Codablock A Msg. Length	Minimum (1 - 600) *1	CBAMIN####	<a href="#">7-41</a>
	Maximum (1 - 600) *600	CBAMAX####	<a href="#">7-41</a>
Codablock F	Default All Codablock F Settings	CBFDFT	<a href="#">7-40</a>
	*Off	CBFENA0	<a href="#">7-42</a>
	On	CBFENA1	<a href="#">7-42</a>
Codablock F Msg. Length	Minimum (1 - 2048) *1	CBFMIN####	<a href="#">7-42</a>
	Maximum (1 - 2048) *2048	CBFMAX####	<a href="#">7-42</a>
PDF417	Default All PDF417 Settings	PDFDFT	<a href="#">7-43</a>
	*On	PDFENA1	<a href="#">7-43</a>
	Off	PDFENA0	<a href="#">7-43</a>

<b>Selection</b>	<b>Setting</b> <i>* Indicates default</i>	<b>Serial Command</b> <i># Indicates a numeric entry</i>	<b>Page</b>
PDF417 Msg. Length	Minimum (1-2750) *1	PDFMIN	7-43
	Maximum (1-2750) *2750	PDFMAX	7-43
MacroPDF417	*On	PDFMAC1	7-44
	Off	PDFMAC0	7-44
MicroPDF417	Default All Micro PDF417 Settings	MPDDFT	7-44
	On	MPDENA1	7-44
	*Off	MPDENA0	7-44
MicroPDF417 Msg. Length	Minimum (1-366) *1	MPDMIN	7-45
	Maximum (1-366) *366	MPDMAX	7-45
GS1 Composite Codes	On	COMENA1	7-45
	*Off	COMENA0	7-45
UPC/EAN Version	On	COMUPC1	7-45
	*Off	COMUPC0	7-45
GS1 Composite Codes Msg. Length	Minimum (1-2435) *1	COMMIN	7-46
	Maximum (1-2435) *2435	COMMAX	7-46
GS1 Emulation	GS1-128 Emulation	EANEMU1	7-47
	GS1 DataBar Emulation	EANEMU2	7-47
	GS1 Code Expansion Off	EANEMU3	7-47
	EAN8 to EAN13 Conversion	EANEMU4	7-47
	*GS1 Emulation Off	EANEMU0	7-47
TCIF Linked Code 39	On	T39ENA1	7-47
	*Off	T39ENA0	7-47

<b>Selection</b>	<b>Setting</b> <i>* Indicates default</i>	<b>Serial Command</b> <i># Indicates a numeric entry</i>	<b>Page</b>
QR Code	Default All QR Code Settings	QRCDFT	<a href="#">7-55</a>
	*On	QRCENA1	<a href="#">7-48</a>
	Off	QRCENA0	<a href="#">7-48</a>
QR Code Msg. Length	Minimum (1-7089) *1	QRCMIN	<a href="#">7-48</a>
	Maximum (1-7089) *7089	QRCMAX	<a href="#">7-48</a>
QR Code Append	*On	QRCAPP1	<a href="#">7-49</a>
	Off	QRCAPP0	<a href="#">7-49</a>
QR Code Page	QR Code Page (*3)	QRCDCP##	<a href="#">7-49</a>
Data Matrix	Default All Data Matrix Settings	IDMDFT	<a href="#">7-50</a>
	*On	IDMENA1	<a href="#">7-50</a>
	Off	IDMENA0	<a href="#">7-50</a>
Data Matrix Msg. Length	Minimum (1-3116) *1	IDMMIN	<a href="#">7-50</a>
	Maximum (1-3116) *3116	IDMMAX	<a href="#">7-50</a>
Data Matrix Append	*On	IDMAPP1	<a href="#">7-51</a>
	Off	IDMAPP0	<a href="#">7-51</a>
Data Matrix Code Page	Data Matrix Code Page (*51)	IDMDCP##	<a href="#">7-51</a>
MaxiCode	Default All MaxiCode Settings	MAXDFT	<a href="#">7-52</a>
	On	MAXENA1	<a href="#">7-52</a>
	*Off	MAXENA0	<a href="#">7-52</a>
MaxiCode Msg. Length	Minimum (1-150) *1	MAXMIN	<a href="#">7-52</a>
	Maximum (1-150) *150	MAXMAX	<a href="#">7-52</a>
Aztec Code	Default All Aztec Code Settings	AZTDFT	<a href="#">7-53</a>
	*On	AZTENA1	<a href="#">7-53</a>
	Off	AZTENA0	<a href="#">7-53</a>



<b>Selection</b>	<b>Setting</b> <i>* Indicates default</i>	<b>Serial Command</b> <i># Indicates a numeric entry</i>	<b>Page</b>
Aztec Code Msg. Length	Minimum (1-3832) *1	AZTMIN	<a href="#">7-53</a>
	Maximum (1-3832) *3832	AZTMAX	<a href="#">7-53</a>
Aztec Append	On	AZTAPP1	<a href="#">7-54</a>
	*Off	AZTAPP0	<a href="#">7-54</a>
Aztec Code Page	Aztec Code Page (*51)	AZTDCP##	<a href="#">7-54</a>
Chinese Sensible (Han Xin) Code	Default All Han Xin Code Settings	HX_DFT	<a href="#">7-55</a>
	On	HX_ENA1	<a href="#">7-55</a>
	*Off	HX_ENA0	<a href="#">7-55</a>
Chinese Sensible (Han Xin) Code Msg. Length	Minimum (1-7833) *1	HX_MIN	<a href="#">7-55</a>
	Maximum (1-7833) *7833	HX_MAX	<a href="#">7-55</a>
<b><i>Postal Codes - 2D</i></b>			
2D Postal Codes	*Off	POSTAL0	<a href="#">7-56</a>
Single 2D Postal Codes	Australian Post On	POSTAL1	<a href="#">7-56</a>
	British Post On	POSTAL7	<a href="#">7-56</a>
	Canadian Post On	POSTAL30	<a href="#">7-56</a>
	Intelligent Mail Bar Code On	POSTAL10	<a href="#">7-56</a>
	Japanese Post On	POSTAL3	<a href="#">7-56</a>
	KIX Post On	POSTAL4	<a href="#">7-56</a>
	Planet Code On	POSTAL5	<a href="#">7-56</a>
	Postal-4i On	POSTAL9	<a href="#">7-56</a>
	Postnet On	POSTAL6	<a href="#">7-57</a>
	Postnet with B and B' Fields On	POSTAL11	<a href="#">7-57</a>
InfoMail On	POSTAL2	<a href="#">7-57</a>	

<b>Selection</b>	<b>Setting</b> <i>* Indicates default</i>	<b>Serial Command</b> <i># Indicates a numeric entry</i>	<b>Page</b>
Combination 2D Postal Codes	InfoMail and British Post On	POSTAL8	<a href="#">7-57</a>
	Intelligent Mail Bar Code and Postnet with B and B' Fields On	POSTAL20	<a href="#">7-57</a>
	Postnet and Postal-4i On	POSTAL14	<a href="#">7-57</a>
	Postnet and Intelligent Mail Bar Code On	POSTAL16	<a href="#">7-57</a>
	Postal-4i and Intelligent Mail Bar Code On	POSTAL17	<a href="#">7-57</a>
	Postal-4i and Postnet with B and B' Fields On	POSTAL19	<a href="#">7-57</a>
	Planet and Postnet On	POSTAL12	<a href="#">7-57</a>
	Planet and Postnet with B and B' Fields On	POSTAL18	<a href="#">7-57</a>
	Planet and Postal-4i On	POSTAL13	<a href="#">7-58</a>
	Planet and Intelligent Mail Bar Code On	POSTAL15	<a href="#">7-58</a>
	Planet, Postnet, and Postal-4i On	POSTAL21	<a href="#">7-58</a>
	Planet, Postnet, and Intelligent Mail Bar Code On	POSTAL22	<a href="#">7-58</a>
Planet, Postal-4i, and Intelligent Mail Bar Code On	POSTAL23	<a href="#">7-58</a>	

<b>Selection</b>	<b>Setting</b> <i>* Indicates default</i>	<b>Serial Command</b> <i># Indicates a numeric entry</i>	<b>Page</b>
Combination 2D Postal Codes (continued)	Postnet, Postal-4i, and Intelligent Mail Bar Code On	POSTAL24	<a href="#">7-58</a>
	Planet, Postal-4i, and Postnet with B and B' Fields On	POSTAL25	<a href="#">7-58</a>
	Planet, Intelligent Mail Bar Code, and Postnet with B and B' Fields On	POSTAL26	<a href="#">7-58</a>
	Postal-4i, Intelligent Mail Bar Code, and Postnet with B and B' Fields On	POSTAL27	<a href="#">7-58</a>
	Planet, Postal-4i, Intelligent Mail Bar Code, and Postnet On	POSTAL28	<a href="#">7-58</a>
	Planet, Postal-4i, Intelligent Mail Bar Code, and Postnet with B and B' Fields On	POSTAL29	<a href="#">7-58</a>
Planet Code Check Digit	Transmit	PLNCKX1	<a href="#">7-59</a>
	*Don't Transmit	PLNCKX0	<a href="#">7-59</a>
Postnet Check Digit	Transmit	NETCKX1	<a href="#">7-59</a>
	*Don't Transmit	NETCKX0	<a href="#">7-59</a>
Australian Post Interpretation	Bar Output	AUSINT0	<a href="#">7-60</a>
	Numeric N Table	AUSINT1	<a href="#">7-60</a>
	Alphanumeric C Table	AUSINT2	<a href="#">7-60</a>
	Combination N and C Tables	AUSINT3	<a href="#">7-60</a>

<b>Selection</b>	<b>Setting</b> <i>* Indicates default</i>	<b>Serial Command</b> <i># Indicates a numeric entry</i>	<b>Page</b>
<b><i>Postal Codes - Linear</i></b>			
China Post (Hong Kong 2 of 5)	Default All China Post (Hong Kong 2 of 5) Settings	CPCDFT	<a href="#">7-60</a>
	*Off	CPCENA0	<a href="#">7-61</a>
	On	CPCENA1	<a href="#">7-61</a>
China Post (Hong Kong 2 of 5) Msg. Length	Minimum (2 - 80) *4	CPCMIN##	<a href="#">7-61</a>
	Maximum (2 - 80) *80	CPCMAX##	<a href="#">7-61</a>
Korea Post	Default All Korea Post Settings	KPCDFT	<a href="#">7-62</a>
	*Off	KPCENA0	<a href="#">7-62</a>
	On	KPCENA1	<a href="#">7-62</a>
Korea Post Msg. Length	Minimum (2 - 80) *4	KPCMIN##	<a href="#">7-62</a>
	Maximum (2 - 80) *48	KPCMAX##	<a href="#">7-62</a>
Korea Post Check Digit	Transmit Check Digit	KPCCHK1	<a href="#">7-62</a>
	*Don't Transmit Check Digit	KPCCHK0	<a href="#">7-62</a>

<b>Selection</b>	<b>Setting</b> <i>* Indicates default</i>	<b>Serial Command</b> <i># Indicates a numeric entry</i>	<b>Page</b>
<b>Imaging Default Commands</b>			
Image Snap	Default all Imaging Commands	IMGDFT	8-1
	Imaging Style - Decoding	SNPSTY0	8-2
	*Imaging Style - Photo	SNPSTY1	8-2
	Imaging Style - Manual	SNPSTY2	8-2
	Beeper On	SNPBEP1	8-2
	*Beeper Off	SNPBEP0	8-2
	*Wait for Trigger Off	SNPTRG0	8-2
	Wait for Trigger On	SNPTRG1	8-2
	*LED State - Off	SNPLED0	8-2
	LED State - On	SNPLED1	8-2
	Exposure (1-7874 microseconds)	SNPEXP	8-3
	*Gain - None	SNPGAN1	8-3
	Gain - Medium	SNPGAN2	8-3
	Gain - Heavy	SNPGAN4	8-3
	Gain - Maximum	SNPGAN8	8-3
	Target White Value (0-255) *125	SNPWHT###	8-4
	Delta for Acceptance (0-255) *25	SNPDEL###	8-4
	Update Tries (0-10) *6	SNPTRY##	8-4
	Target Set Point Percentage (1-99) *50	SNPPCT##	8-4

<b>Selection</b>	<b>Setting</b> <i>* Indicates default</i>	<b>Serial Command</b> <i># Indicates a numeric entry</i>	<b>Page</b>
Image Ship	*Infinity Filter - Off	IMGINF0	8-5
	Infinity Filter - On	IMGINF1	8-5
	*Compensation Off	IMGCOR0	8-6
	Compensation On	IMGCOR1	8-6
	*Pixel Depth - 8 bits/ pixel (grayscale)	IMGBPP8	8-6
	Pixel Depth - 1 bit/ pixel (B&W)	IMGBPP1	8-6
	*Don't Sharpen Edges	IMGEDG0	8-7
	Sharpen Edges (0- 23)	IMGEDG##	8-7
	*File Format - JPEG	IMGFMT6	8-7
	File Format - KIM	IMGFMT0	8-7
	File Format - TIFF binary	IMGFMT1	8-7
	File Format - TIFF binary group 4, compressed	IMGFMT2	8-7
	File Format - TIFF grayscale	IMGFMT3	8-7
	File Format - Uncompressed binary	IMGFMT4	8-7
	File Format - Uncompressed grayscale	IMGFMT5	8-7
	File Format - BMP	IMGFMT8	8-7
	*Histogram Stretch Off	IMGHIS0	8-8
	Histogram Stretch On	IMGHIS1	8-8
	*Noise Reduction Off	IMGFSP0	8-9
	Noise Reduction On	IMGFSP1	8-9

<b>Selection</b>	<b>Setting</b> <i>* Indicates default</i>	<b>Serial Command</b> <i># Indicates a numeric entry</i>	<b>Page</b>
Image Ship (continued)	Invert Image around X axis	IMGNVX1	8-8
	Invert Image around Y axis	IMGNVY1	8-8
	Rotate Image none	IMGROT0	8-9
	Rotate Image 90° right	IMGROT1	8-9
	Rotate Image 180° right	IMGROT2	8-9
	Rotate Image 90° left	IMGROT3	8-9
	JPEG Image Quality (0-100) *50	IMGJQF###	8-10
	*Gamma Correction Off	IMGGAM0	8-10
	Gamma Correction On (0-1000)	IMGGAM###	8-10
	Image Crop - Left (0-843) *0	IMGWNL###	8-10
	Image Crop - Right (0-843) *843	IMGWNR###	8-10
	Image Crop - Top (0-639) *0	IMGWNT###	8-10
	Image Crop - Bottom (0-639) *639	IMGWNB###	8-11
	Image Crop - Margin (1-238) *0	IMGMAR###	8-11
	Protocol - None (raw)	IMGXFR0	8-11
	Protocol - None (default USB)	IMGXFR2	8-11
	Protocol - Hmodem Compressed	IMGXFR3	8-11
	Protocol - Hmodem	IMGXFR4	8-11
	Ship Every Pixel	IMGSUB1	8-12

<b>Selection</b>	<b>Setting</b> <i>* Indicates default</i>	<b>Serial Command</b> <i># Indicates a numeric entry</i>	<b>Page</b>
Image Ship (continued)	Ship Every 2nd Pixel	IMGSUB2	<a href="#">8-12</a>
	Ship Every 3rd Pixel	IMGSUB3	<a href="#">8-12</a>
	*Document Image Filter Off	IMGUSH0	<a href="#">8-12</a>
	Document Image Filter On (0-255)	IMGUSH###	<a href="#">8-12</a>
	*Don't Ship Histogram	IMGHST0	<a href="#">8-13</a>
	Ship Histogram	IMGHST1	<a href="#">8-13</a>
Image Size Compatibility	Force VGA Resolution	IMGVGA1	<a href="#">8-14</a>
	*Native Resolution	IMGVGA0	<a href="#">8-14</a>
Intelligent Signature Capture	Optimize On	DECBND1	<a href="#">8-14</a>
	*Optimize Off	DECBND0	<a href="#">8-14</a>



## 1900/1910 Scanner Product Specifications

Parameter	Specification
Dimensions (Typical):	
Height	6.3 inches (16cm)
Length	4.1 inches (10.41cm)
Width	2.8 inches (7.11cm)
Weight	5.2 ounces (147.42g)
Illumination LED:	
Peak Wavelength	624nm $\pm$ 18nm (red LED) IEC 62471: "Exempt Risk Group"  442nm, 552nm (white LED) IEC 62471: "Exempt Risk Group"
Aiming:	
Peak Wavelength Laser	650nm IEC 60825-1: "Class 2"
Peak Wavelength LED	624nm $\pm$ 18nm IEC 62471: "Exempt Risk Group"
Optical Power Laser	<1mW
Image Size	838 x 640 pixels
Skew Angle	$\pm$ 65°
Pitch Angle	$\pm$ 45°
Motion Tolerance: Streaming Presentation Trigger	up to 240 inches per second for 13 mil UPC
Symbol Contrast	Grade 1.0 (20% or greater)
Voltage Requirements	4 - 5.5 VDC at input connector
Current Draw @5VDC	<u>Scanning</u> <u>Standby</u>
B&W	470mA, 2.35W                      90mA, .45W
Color	490mA, 2.45W                      90mA, .45W
Power Supply Noise Rejection	Maximum 100mV peak to peak, 10 to 100 kHz
Temperature Ranges:	
Operating	+32°F to +122°F (0°C to 50°C)
Storage	-40°F to +158°F (-40°C to 70°C)

Parameter	Specification
Humidity	0 to 95% non-condensing
Mechanical Drop	Operational after 50 drops from 6 feet (1.83m) to concrete at 23°C
Vibration	Withstands 5G peak from 22 to 300 Hz
ESD Tolerance	Up to 15kV direct air Up to 8 kV indirect coupling plane

## ***1902/1912 Scanner Product Specifications***

Parameter	Specification
Dimensions (Typical):	
Height	6.3 inches (16 cm)
Length	4.1 inches (10.41cm)
Width	2.8 inches (7.11cm)
Weight	7.5 ounces (212.62g)
Illumination LED:	
Peak Wavelength	624nm ± 18nm (red LED) IEC 62471: "Exempt Risk Group" 442nm, 552nm (white LED) IEC 62471: "Exempt Risk Group"
Aiming:	
Peak Wavelength Laser	650nm IEC 60825-1: "Class 2"
Peak Wavelength LED	624nm ± 18nm IEC 62471: "Exempt Risk Group"
Optical Power Laser	<1mW
Image Size	838 x 640 pixels
Skew Angle	±65°
Pitch Angle	±45°
Motion Tolerance:	
Streaming Presentation Trigger	up to 240 inches per second for 13 mil UPC
Symbol Contrast	Grade 1.0 (20% or greater)
Battery:	
Lithium Ion	1800 mAHr minimum
Number of Scans	Up to 50,000 per charge
Expected Hours of Operation	14
Expected Charge Time	4.5 hours

<b>Parameter</b>	<b>Specification</b>
Radio:	
Frequency	2.4 to 2.5 GHz (ISM Band) Frequency Hopping Bluetooth v.2.1
Range	33 ft. (10 m) typical
Data Rate	Up to 1 MBps
Temperature Ranges:	
Operating	32° F to +122° F (0° C to 50° C)
Storage*	-40°F to +158°F (-40°C to 70°C)
Humidity	Up to 95% non-condensing
Mechanical Drop	Operational after 50 drops from 6 feet (1.8 m) to concrete
Vibration	Withstands 5G peak from 22 to 300 Hz
ESD Sensitivity	Up to 15kV direct air Up to 8 kV indirect coupling plane
Sealant Rating	IP41

\*Storage outside of this temperature range could be detrimental to battery life.

## ***CCB01-010BT Charge Base Product Specifications***

<b>Parameter</b>	<b>Specification</b>
Dimensions (Typical):	
Height	3.2 inches (8.128cm)
Length	5.19 inches (13.183cm)
Width	3.98 inches (10.109cm)
Weight	6.3 oz (179g)
Voltage:	4.5 to 5.5 volts
Current Draw:	
Host Terminal Port	500mA
Aux Power Port	1A
Charge Time	5 hours
Radio:	
Frequency	2.4 to 2.5 GHz (ISM Band) Frequency Hopping Bluetooth v.2.1
Range	33 ft. (10 m) typical
Data Rate	Up to 1 MBps

---

<b>Parameter</b>	<b>Specification</b>
Temperature Ranges: Operating Battery Charge Storage	32° F to +122° F (0° C to +50° C) 41° F to +104° F (5° C to +40° C) -40° F to +158° F (-40° C to +70° C)
Humidity	Up to 95% non-condensing
Mechanical Drop	Operational after 50 drops from 3.28 feet (1 m) to concrete
Vibration	5G Peak from 22Hz to 300Hz
ESD Sensitivity	Up to 15kV direct air Up to 8 kV indirect coupling plane

# Depth of Field Charts

## B&W Scanner Typical Performance

Focus		High Density (HD)		Standard Range (SR)		Extended Range (ER)	
		Near Distance	Far Distance	Near Distance	Far Distance	Near Distance	Far Distance
5 mil Code 39	in.	0	4.1	1.1	5.3	3.7	8
	mm	0	104.1	27.9	134.6	94	203.2
13 mil UPC	in.	.4	6.6	.4	17.3	1	20.7
	mm	10.2	167.6	10.2	439.4	25.4	525.8
20 mil Code 39	in.	.4	9.2	.5	23	1	23.5
	mm	10.2	233.7	12.7	584.2	25.4	596.9
6.7 mil PDF417	in.	0	4.3	.4	6.1	2.8	9.2
	mm	0	109.2	10.2	154.9	71.1	233.7
10 mil Data Matrix	in.	0	5	.5	7.5	2.5	11.3
	mm	0	127	12.7	190.5	63.5	287
20 mil QR Code	in.	.4	7.5	.6	15.1	.7	19
	mm	10.2	190.5	15.2	383.5	17.8	482.6
Resolution (1D Code 39)		3 mil (.076mm)		5 mil (.127mm)		5 mil (.127mm)	
Resolution (2D Data Matrix)		5 mil (.127mm)		6.7 mil (.170mm)		7.5 mil (.191mm)	

## ***B&W Scanner Guaranteed Performance***

Focus		High Density (HD)		Standard Range (SR)		Extended Range (ER)	
		Near Distance	Far Distance	Near Distance	Far Distance	Near Distance	Far Distance
Symbology							
5 mil Code 39	in.	0	3.6	1.7	5	4.2	7.8
	mm	0	91.4	43.2	127	106.7	198.1
13 mil UPC	in.	.6	5.5	.4	15.8	1.1	19.7
	mm	15.2	139.7	10.2	401.3	27.9	500.4
20 mil Code 39	in.	.6	8.2	.5	18.2	1.5	25
	mm	15.2	208.3	12.7	462.3	38.1	635
6.7 mil PDF417	in.	0	3.8	.6	6	3.3	8.7
	mm	0	96.5	15.2	152.4	83.8	221
10 mil Data Matrix	in.	0	4.3	.9	6.5	3.4	10.3
	mm	0	109.2	22.9	165.1	86.4	261.6
20 mil QR Code	in.	.8	6.7	.7	13.9	.9	18
	mm	20.3	170.2	17.8	353.1	22.9	457.2
Resolution (1D Code 39)		3 mil (.076mm)		5 mil (.127mm)		5 mil (.127mm)	
Resolution (2D Data Matrix)		5 mil (.127mm)		6.7 mil (.170mm)		7.5 mil (.191mm)	

## ***Color Scanner (Model COL) Typical Performance***

<b>Focus</b>		<b>High Density (HD)</b>		<b>Standard Range (SR)</b>	
		Near Distance	Far Distance	Near Distance	Far Distance
Symbology		Near Distance	Far Distance	Near Distance	Far Distance
5 mil Code 39	in.	0	3.6	1.1	5.2
	mm	0	91.4	27.9	132.1
13 mil UPC	in.	.4	5.9	.4	16.2
	mm	10.2	149.9	10.2	411.5
20 mil Code 39	in.	.4	8.4	.5	22
	mm	10.2	213.4	12.7	558.8
6.7 mil PDF417	in.	0	3.8	.4	6
	mm	0	96.5	10.2	152.4
10 mil Data Matrix	in.	0	4.2	.5	7
	mm	0	106.7	12.7	177.8
20 mil QR Code	in.	.4	6.8	.6	13.4
	mm	10.2	172.7	15.2	340.4
Resolution (1D Code 39)		3 mil (.076mm)		5 mil (.127mm)	
Resolution (2D Data Matrix)		5 mil (.127mm)		6.7 mil (.170mm)	

## Color Scanner (Model COL) Guaranteed Performance

Focus		High Density (HD)		Standard Range (SR)	
		Near Distance	Far Distance	Near Distance	Far Distance
Symbology					
5 mil Code 39	in.	0	3.3	1.7	4.9
	mm	0	83.8	43.2	124.5
13 mil UPC	in.	.6	5.2	.4	14.5
	mm	15.2	132.1	10.2	368.3
20 mil Code 39	in.	.5	7.4	.5	17.5
	mm	12.7	188	12.7	444.5
6.7 mil PDF417	in.	0	3.4	.5	5.7
	mm	0	86.4	12.7	144.8
10 mil Data Matrix	in.	0	4	.8	6.4
	mm	0	101.6	20.3	162.6
20 mil QR Code	in.	.7	6.2	.7	12.3
	mm	17.8	157.5	17.8	312.4
Resolution (1D Code 39)		3 mil (.076mm)		5 mil (.127mm)	
Resolution (2D Data Matrix)		5 mil (.127mm)		6.7 mil (.170mm)	

## CCB01-010BT Charge Base Mounting

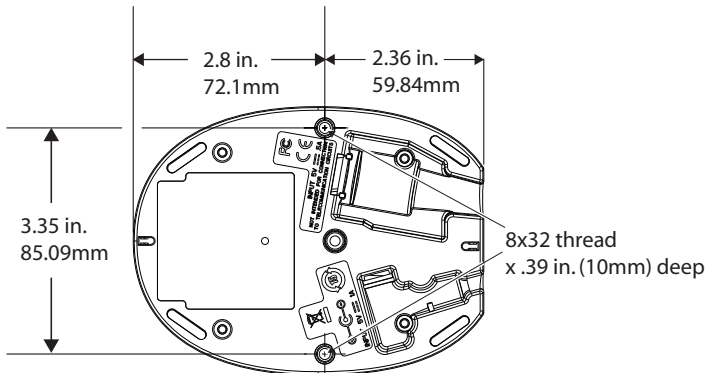



---

# Standard Cable Pinouts

## Keyboard Wedge

**10 Pin RJ41 Modular Plug**  
connects to the base

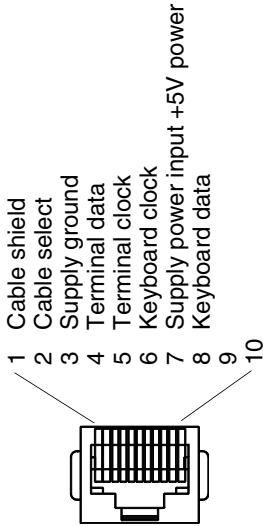

**Note:** Pin assignments are not compatible with Honeywell legacy products.  
Use of a cable with improper pin assignments may lead to damage to the unit.  
Use of any cables not provided by the manufacturer may result in damage not covered by your warranty.

---

# Standard Cable Pinouts

## Serial Output

**10 Pin RJ41 Modular Plug**  
connects to the base

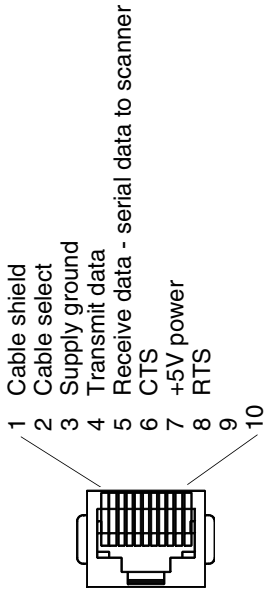

*Note: Pin assignments are not compatible with Honeywell legacy products.  
Use of a cable with improper pin assignments may lead to damage to the unit.  
Use of any cables not provided by the manufacturer may result in damage not covered by your warranty.*

---

## Standard Cable Pinouts

### RS485 Output

**10 Pin RJ41 Modular Plug**  
connects to the base

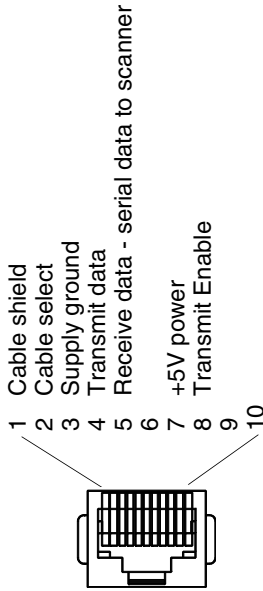

**Note:** RS485 signal conversion is performed in the cable.  
Pin assignments are not compatible with Honeywell legacy products.  
Use of a cable with improper pin assignments may lead to damage to the unit.  
Use of any cables not provided by the manufacturer may result in damage not covered by your warranty.

---

# Standard Cable Pinouts

## USB

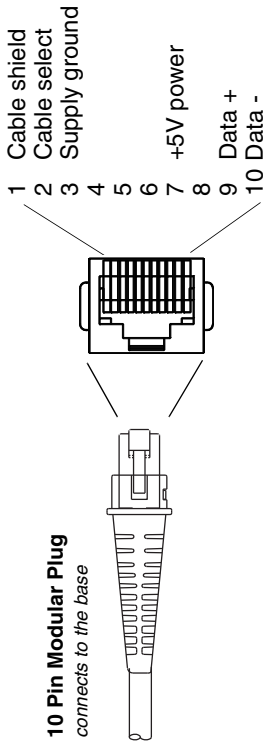

*Note: Pin assignments are not compatible with Honeywell legacy products.  
Use of a cable with improper pin assignments may lead to damage to the unit.  
Use of any cables not provided by the manufacturer may result in damage not covered by your warranty.*

## Repairs

Repairs and/or upgrades are not to be performed on this product. These services are to be performed only by an authorized service center (see [Customer Support](#) on page 14-1).

## Maintenance

Your device provides reliable and efficient operation with a minimum of care. Although specific maintenance is not required, the following periodic checks ensure dependable operation:

### ***Cleaning the Scanner***

The scanner or base's housing may be cleaned with a soft cloth or tissue dampened with water (or a mild detergent-water solution.) If a detergent solution is used, rinse with a clean tissue dampened with water only.



#### **Caution:**

**Do not submerge the scanner in water. The scanner's housing is not watertight.**

**Do not use abrasive wipes or tissues on the scanner's window – abrasive wipes may scratch the window. Never use solvents (e.g., acetone) on the housing or window – solvents may damage the finish or the window.**

### ***Cleaning the Window***

Reading performance may degrade if the scanner's window is not clean. If the window is visibly dirty, or if the scanner isn't operating well, clean the window with one of the cleaning solutions listed for [Health Care Housing](#), below.

### ***Health Care Housing***

Some configurations of Xenon scanners are available with an external plastic housing that is designed to resist the effects of harsh chemicals in a health care environment. The plastic is crystalline in nature, which helps prevent chemicals from seeping through the housing.

---

**Important!** The following cleaning solutions have been tested to assure safe cleaning of your scanner's disinfectant-ready housing. They are the only solutions approved for use with these scanners. Damage caused by the use of cleaners other than those listed below may not be covered by the warranty.

- Sani-Cloth<sup>®</sup> HB wipes
- Sani-Cloth<sup>®</sup> Plus wipes
- Super Sani-Cloth<sup>®</sup> wipes
- Isopropyl Alcohol wipes (70%)
- CaviWipes<sup>™</sup>
- Virex<sup>®</sup> 256
- 409<sup>®</sup> Glass and Surface Cleaner
- Windex<sup>®</sup> Blue
- Clorox<sup>®</sup> Bleach – 10%
- Gentle dish soap and water

### ***Inspecting Cords and Connectors***

Inspect the interface cable and connector for wear or other signs of damage. A badly worn cable or damaged connector may interfere with scanner operation. Contact your distributor for information about cable replacement. Cable replacement instructions are on [page 13-2](#).

### ***Replacing Cables in Corded Scanners***

The standard interface cable is attached to the scanner with an 10-pin modular connector. When properly seated, the connector is held in the scanner's handle by a flexible retention tab. The interface cable is designed to be field replaceable.

- Order replacement cables from Honeywell or from an authorized distributor.
- When ordering a replacement cable, specify the cable part number of the original interface cable.

---

## ***Replacing an Interface Cable***

1. Turn the power to the host system OFF.
2. Disconnect the scanner's cable from the terminal or computer.
3. Locate the small hole on the back of the scanner's handle. This is the cable release.
4. Straighten one end of a paper clip.
5. Insert the end of the paper clip into the small hole and press in. This depresses the retention tab, releasing the connector. Pull the connector out while maintaining pressure on the paper clip, then remove the paper clip.
6. Replace with the new cable.  
Insert the connector into the opening and press firmly. The connector is keyed to go in only one way, and will click into place.

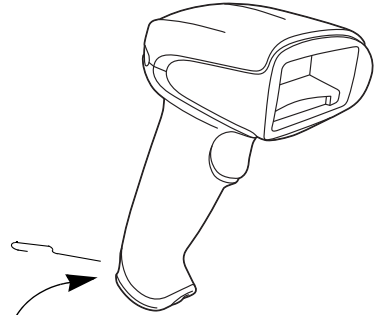

***Cable Release***

## ***Replacing Cables and Batteries in Cordless Systems***

### ***Replacing an Interface Cable in a Base***

1. Turn the power to the host system OFF.
2. Disconnect the base's cable from the terminal or computer.
3. Turn the base upside down.
4. Pull the connector out while maintaining pressure on the connector release clip.
5. Replace with the new cable.  
Insert the connector into the opening and press firmly. The connector is keyed to go in only one way, and will click into place.

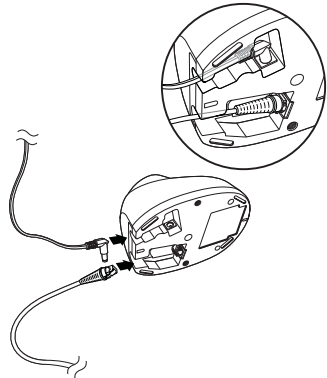

---

## **Changing a scanner Battery**

1. Loosen the thumb wheel screw on the end cap by hand or use a hex wrench.
2. Remove the battery from the handle.
3. Insert replacement battery.
4. Replace end cap and screw.

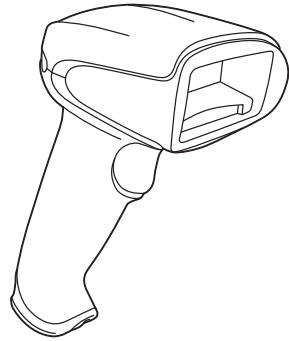

**End Cap** →

## **Troubleshooting a Xenon Scanner**

The scanner automatically performs self-tests whenever you turn it on. If your scanner is not functioning properly, review the following Troubleshooting Guide to try to isolate the problem.

### ***Is the power on? Is the aiming beam on?***

If the aiming beam isn't illuminated, check that:

- The cable is connected properly.
- The host system power is on (if external power isn't used).
- The trigger works.

### ***Is the scanner having trouble reading your symbols?***

If the scanner isn't reading symbols well, check that the symbols:

- Aren't smeared, rough, scratched, or exhibiting voids.
- Aren't coated with frost or water droplets on the surface.
- Are enabled in the scanner or in the decoder to which the scanner connects.

### ***Is the bar code displayed but not entered?***

The bar code is displayed on the host device correctly, but you still have to press a key to enter it (the Enter/Return key or the Tab key, for example).

- You need to program a suffix. Programming a suffix enables the scanner to output the bar code data plus the key you need (such as "CR") to enter the data into your application. Refer to [Prefix/Suffix Overview](#) on page 5-1 for further information.

### ***Does the scanner read the bar code incorrectly?***

If the scanner reads a bar code, but the data is not displayed correctly on the host screen:



- 
- The scanner may not be programmed for the appropriate terminal interface.  
For example, you scan “12345” and the host displays “@es%.”

Reprogram the scanner with the correct Plug and Play bar code. See [Programming the Interface](#) beginning on page 2-1.

- The scanner may not be programmed to output your bar code data properly.  
For example, you scan “12345” and the host displays “A12345B.”

Reprogram the scanner with the proper symbology selections. See [Chapter 7](#).

***The scanner won't read your bar code at all.***

1. Scan the sample bar codes in the back of this manual. If the scanner reads the sample bar codes, check that your bar code is readable. Verify that your bar code symbology is enabled (see [Chapter 7](#)).
2. If the scanner still can't read the sample bar codes, scan [All Symbologies On](#), page 7-2.

If you aren't sure what programming options have been set in the scanner, or if you want the factory default settings restored, refer to [Resetting the Factory Defaults](#) on page 1-11.

## ***Troubleshooting a Cordless System***

### ***Troubleshooting a Base***

*Note:* Visit the *Services and Support* section of our website ([www.honeywellaidc.com](http://www.honeywellaidc.com)) to check for the latest software for both the scanner and the base.

If your base is not functioning properly, review the following troubleshooting guidelines to try to isolate the problem.

#### ***Is the red LED on?***

If the red LED isn't illuminated, check that:

- The power cable is connected properly and there is power at the power source.
- The host system power is on (if external power isn't used).

#### ***Is the green LED on?***

If the *green* LED isn't illuminated, check that:

- The scanner is correctly placed in the base.
- There is external power or 12 volt host power.
- Charge mode is turned on. (See ["Beeper and LED Sequences and Meaning"](#) on page 3-6)
- The battery is not bad or deeply discharged. In some cases, the scanner's battery may trickle charge to bring it into an acceptable level and then transition to a normal charge cycle.

---

## **Troubleshooting a Cordless Scanner**

*Note: Make sure that your scanner's battery is charged. Visit the Services and Support section of our website ([www.honeywellaidc.com](http://www.honeywellaidc.com)) to check for the latest software for both the scanner and the base or Access Point.*

### **Is the scanner having trouble reading your symbols?**

If the scanner isn't reading symbols well, check that the symbols:

- Aren't smeared, rough, scratched, or exhibiting voids.
- Aren't coated with frost or water droplets on the surface.
- Are enabled in the base or Access Point to which the scanner connects.

### **Is the bar code displayed but not entered into the application?**

The bar code is displayed on the host device correctly, but you still have to press a key to enter it (the Enter/Return key or the Tab key, for example).

- You need to program a suffix. Programming a suffix enables the scanner to output the bar code data plus the key you need (such as "CR") to enter the data into your application. Refer to [Prefix/Suffix Overview](#) on page 5-1 for further information.

### **Does the scanner read the bar code incorrectly?**

If the scanner reads a bar code, but the data is not displayed correctly on the host screen:

- The base or Access Point may not be programmed for the appropriate terminal interface. For example, you scan "12345" and the host displays "@es%."

Reprogram the base/Access Point with the correct Plug and Play bar code. See [Programming the Interface](#) beginning on page 2-1.

- The base or Access Point may not be programmed to output your bar code data properly. For example, you scan "12345" and the host displays "A12345B."

Reprogram the base/Access Point with the proper symbology selections. See [Chapter 7](#).

### **The scanner won't read your bar code at all.**

- Scan the sample bar codes in the back of this manual. If the scanner reads the sample bar codes, check that your bar code is readable.

Verify that your bar code symbology is enabled (see [Chapter 7](#)).

If the scanner still can't read the sample bar codes, scan [All Symbologies](#) on page 7-2.

## **Technical Assistance**

If you need assistance installing or troubleshooting your device, please contact us by using one of the methods below:

**Knowledge Base:** [www.hsmknowledgebase.com](http://www.hsmknowledgebase.com)

Our Knowledge Base provides thousands of immediate solutions. If the Knowledge Base cannot help, our Technical Support Portal (see below) provides an easy way to report your problem or ask your question.

**Technical Support Portal:** [www.hsmsupportportal.com](http://www.hsmsupportportal.com)

The Technical Support Portal not only allows you to report your problem, but it also provides immediate solutions to your technical issues by searching our Knowledge Base. With the Portal, you can submit and track your questions online and send and receive attachments.

**Web form:** [www.hsmcontactsupport.com](http://www.hsmcontactsupport.com)

You can contact our technical support team directly by filling out our online support form. Enter your contact details and the description of the question/problem.

**Telephone:** [www.honeywellaidc.com/locations](http://www.honeywellaidc.com/locations)

For our latest contact information, please check our website at the link above.

## **Product Service and Repair**

Honeywell International Inc. provides service for all its products through service centers throughout the world. To obtain warranty or non-warranty service, contact the appropriate location below to obtain a Return Material Authorization number (RMA #) before returning the product.

### **North America**

Telephone: (800) 782-4263

E-mail: [hsmnaservice@honeywell.com](mailto:hsmnaservice@honeywell.com)

### **Latin America**

Telephone: (803) 835-8000

Telephone: (800) 782-4263

Fax: (239) 263-9689

E-mail: [laservice@honeywell.com](mailto:laservice@honeywell.com)

### **Brazil**

Telephone: +55 (11) 5185-8222

Fax: +55 (11) 5185-8225

E-mail: [brservice@honeywell.com](mailto:brservice@honeywell.com)

---

## **Mexico**

Telephone: 01-800-HONEYWELL (01-800-466-3993)

Fax: +52 (55) 5531-3672

*E-mail: mxservice@honeywell.com*

## **Europe, Middle East, and Africa**

Telephone: +31 (0) 40 2901 633

Fax: +31 (0) 40 2901 631

*E-mail: euroservice@honeywell.com*

## **Hong Kong**

Telephone: +852-29536436

Fax: +852-2511-3557

*E-mail: apservice@honeywell.com*

## **Singapore**

Telephone: +65-6842-7155

Fax: +65-6842-7166

*E-mail: apservice@honeywell.com*

## **China**

Telephone: +86 800 828 2803

Fax: +86-512-6762-2560

*E-mail: apservice@honeywell.com*

## **Japan**

Telephone: +81-3-6730-7344

Fax: +81-3-6730-7222

*E-mail: apservice@honeywell.com*

## ***Online Product Service and Repair Assistance***

You can also access product service and repair assistance online at [www.honeywellaidc.com](http://www.honeywellaidc.com).

## ***Limited Warranty***

Honeywell International Inc. ("HII") warrants its products to be free from defects in materials and workmanship and to conform to HII's published specifications applicable to the products purchased at the time of shipment. This warranty does not cover any HII product which is (i) improperly installed or used; (ii) damaged by accident or negligence, including failure to follow the proper maintenance, service, and cleaning schedule; or (iii) damaged as a result of (A) modification or alteration by the purchaser or other party, (B) excessive voltage or current supplied to or drawn from the interface connections, (C) static electricity or electro-static discharge, (D) operation under conditions beyond the specified operating parameters, or (E) repair or service of the product by any one other than HII or its authorized representatives.

---

This warranty shall extend from the time of shipment for the duration published by HII for the product at the time of purchase ("Warranty Period"). Any defective product must be returned (at purchaser's expense) during the Warranty Period to HII factory or authorized service center for inspection. No product will be accepted by HII without a Return Materials Authorization, which may be obtained by contacting HII. In the event that the product is returned to HII or its authorized service center within the Warranty Period and HII determines to its satisfaction that the product is defective due to defects in materials or workmanship, HII, at its sole option, will either repair or replace the product without charge, except for return shipping to HII.

EXCEPT AS MAY BE OTHERWISE PROVIDED BY APPLICABLE LAW, THE FOREGOING WARRANTY IS IN LIEU OF ALL OTHER COVENANTS OR WARRANTIES, EITHER EXPRESSED OR IMPLIED, ORAL OR WRITTEN, INCLUDING, WITHOUT LIMITATION, ANY IMPLIED WARRANTIES OF MERCHANTABILITY OR FITNESS FOR A PARTICULAR PURPOSE, OR NON-INFRINGEMENT.

HII'S RESPONSIBILITY AND PURCHASER'S EXCLUSIVE REMEDY UNDER THIS WARRANTY IS LIMITED TO THE REPAIR OR REPLACEMENT OF THE DEFECTIVE PRODUCT WITH NEW OR REFURBISHED PARTS. IN NO EVENT SHALL HII BE LIABLE FOR INDIRECT, INCIDENTAL, OR CONSEQUENTIAL DAMAGES, AND, IN NO EVENT, SHALL ANY LIABILITY OF HII ARISING IN CONNECTION WITH ANY PRODUCT SOLD HEREUNDER (WHETHER SUCH LIABILITY ARISES FROM A CLAIM BASED ON CONTRACT, WARRANTY, TORT, OR OTHERWISE) EXCEED THE ACTUAL AMOUNT PAID TO HII FOR THE PRODUCT. THESE LIMITATIONS ON LIABILITY SHALL REMAIN IN FULL FORCE AND EFFECT EVEN WHEN HII MAY HAVE BEEN ADVISED OF THE POSSIBILITY OF SUCH INJURIES, LOSSES, OR DAMAGES. SOME STATES, PROVINCES, OR COUNTRIES DO NOT ALLOW THE EXCLUSION OR LIMITATIONS OF INCIDENTAL OR CONSEQUENTIAL DAMAGES, SO THE ABOVE LIMITATION OR EXCLUSION MAY NOT APPLY TO YOU.

All provisions of this Limited Warranty are separate and severable, which means that if any provision is held invalid and unenforceable, such determination shall not affect the validity of enforceability of the other provisions hereof. Use of any peripherals not provided by the manufacturer may result in damage not covered by this warranty. This includes but is not limited to: cables, power supplies, cradles, and docking stations. HII extends these warranties only to the first end-users of the products. These warranties are non-transferable.

The duration of the limited warranty for the Xenon 1900 scanner is five (5) years.

The duration of the limited warranty for the Xenon 1902 scanner and CCB01-010BT Charge Base is three (3) years.

The duration of the limited warranty for the Xenon battery is one (1) year.



## Symbology Chart

Symbology	AIM ID	Possible AIM ID Modifiers ( <i>m</i> )	Code ID (hex)
<i>All Symbologies</i>			(0x99)
Australian Post	]X0		A (0x41)
Aztec Code	]zm	0-9, A-C	z (0x7A)
Batch Mode Quantity			5 (0x35)
British Post	]X0		B (0x42)
Canadian Post	]X0		C (0x43)
China Post	]X0		Q (0x51)
Chinese Sensible Code (Han Xin Code)	]X0		H (0x48)
Codabar	]F <i>m</i>	0-1	a (0x61)
Codablock A	]O6	0, 1, 4, 5, 6	V (0x56)
Codablock F	]O <i>m</i>	0, 1, 4, 5, 6	q (0x71)
Code 11	]H3		h (0x68)
Code 128	]C <i>m</i>	0, 1, 2, 4	j (0x6A)
GS1-128	]C1		l (0x49)
Code 32 Pharmaceutical (PARAF)	]X0		< (0x3C)
Code 39 (supports Full ASCII mode)	]A <i>m</i>	0, 1, 3, 4, 5, 7	b (0x62)
Code 49	]T <i>m</i>	0, 1, 2, 4	l (0x6C)
Code 93 and 93i	]G <i>m</i>	0-9, A-Z, a-m	i (0x69)
Data Matrix	]d <i>m</i>	0-6	w (0x77)
EAN-13 (including Bookland EAN)	]E0		d (0x64)
EAN-13 with Add-On	]E3		d (0x64)
EAN-13 with Extended Coupon Code	]E3		d (0x64)
EAN-8	]E4		D (0x44)

<b>Symbology</b>	<b>AIM ID</b>	<b>Possible AIM ID Modifiers (m)</b>	<b>Code ID (hex)</b>
EAN-8 with Add-On	]E3		D (0x44)
GS1 Composite	]em	0-3	y (0x79)
GS1 DataBar	]em	0	y (0x79)
GS1 DataBar Limited	]em		{ (0x7B)
GS1 DataBar Omnidirectional	]em		y (0x79)
GS1 DataBar Expanded	]em		} (0x7D)
InfoMail	]X0		, (0x2c)
Intelligent Mail Bar Code	]X0		M (0x4D)
Interleaved 2 of 5	]Im	0, 1, 3	e (0x65)
Japanese Post	]X0		J (0x4A)
KIX (Netherlands) Post	]X0		K (0x4B)
Korea Post	]X0		? (0x3F)
Matrix 2 of 5	]X0		m (0x6D)
MaxiCode	]Um	0-3	x (0x7 8)
MicroPDF417	]Lm	3-5	R (0x52)
MSI	]Mm	0	g (0x67)
NEC 2 of 5	]X0		Y (0x59)
OCR MICR (E 13 B)	]o3		O (0x4F)
OCR SEMI Font	]o3		O (0x4F)
OCR-A	]o1		O (0x4F)
OCR-B	]o2		O (0x4F)
PDF417	]Lm	0-2	r (0x72)
Planet Code	]X0		L (0x4C)
Postal-4i	]X0		N (0x4E)
Postnet	]X0		P (0x50)
QR Code and Micro QR Code	]Qm	0-6	s (0x73)
Straight 2 of 5 IATA	]Rm	0, 1, 3	f (0x66)
Straight 2 of 5 Industrial	]S0		f (0x66)



Symbology	AIM ID	Possible AIM ID Modifiers (m)	Code ID (hex)
TCIF Linked Code 39 (TLC39)	]L2		T (0x54)
Telepen	]Bm		t (0x54)
UPC-A	]E0		c (0x63)
UPC-A with Add-On	]E3		c (0x63)
UPC-A with Extended Coupon Code	]E3		c (0x63)
UPC-E	]E0		E (0x45)
UPC-E with Add-On	]E3		E (0x45)
UPC-E1	]X0		E (0x45)

*Note: “m” represents the AIM modifier character. Refer to International Technical Specification, Symbology Identifiers, for AIM modifier character details.*

*Prefix/Suffix entries for specific symbologies override the universal (All Symbologies, 99) entry.*

Refer to [Data Editing](#) beginning on page 5-1 and [Data Formatting](#) beginning on page 6-1 for information about using Code ID and AIM ID.

## ASCII Conversion Chart (Code Page 1252)

Note: This table applies to U.S. style keyboards. Certain characters may differ depending on your Country Code/PC regional settings.

Non-Printable Characters					
DEC	HEX	Character (Code)	DEC	HEX	Character (Code)
0	0	NULL	16	10	DATA LINK ESCAPE (DLE)
1	1	START OF HEADING (SOH)	17	11	DEVICE CONTROL 1 (DC1)
2	2	START OF TEXT (STX)	18	12	DEVICE CONTROL 2 (DC2)
3	3	END OF TEXT (ETX)	19	13	DEVICE CONTROL 3 (DC3)
4	4	END OF TRANSMISSION (EOT)	20	14	DEVICE CONTROL 4 (DC4)
5	5	END OF QUERY (ENQ)	21	15	NEGATIVE ACKNOWLEDGEMENT (NAK)
6	6	ACKNOWLEDGE (ACK)	22	16	SYNCHRONIZE (SYN)
7	7	BEEP (BEL)	23	17	END OF TRANSMISSION BLOCK (ETB)
8	8	BACKSPACE (BS)	24	18	CANCEL (CAN)
9	9	HORIZONTAL TAB (HT)	25	19	END OF MEDIUM (EM)
10	A	LINE FEED (LF)	26	1A	SUBSTITUTE (SUB)
11	B	VERTICAL TAB (VT)	27	1B	ESCAPE (ESC)
12	C	FF (FORM FEED)	28	1C	FILE SEPARATOR (FS) RIGHT ARROW
13	D	CR (CARRIAGE RETURN)	29	1D	GROUP SEPARATOR (GS) LEFT ARROW
14	E	SO (SHIFT OUT)	30	1E	RECORD SEPARATOR (RS) UP ARROW
15	F	SI (SHIFT IN)	31	1F	UNIT SEPARATOR (US) DOWN ARROW

Printable Characters								
DEC	HEX	Character	DEC	HEX	Character	DEC	HEX	Character
32	20	<SPACE>	64	40	@	96	60	`
33	21	!	65	41	A	97	61	a
34	22	"	66	42	B	98	62	b
35	23	#	67	43	C	99	63	c
36	24	\$	68	44	D	100	64	d
37	25	%	69	45	E	101	65	e
38	26	&	70	46	F	102	66	f
39	27	'	71	47	G	103	67	g

Printable Characters (Continued)								
DEC	HEX	Character	DEC	HEX	Character	DEC	HEX	Character
40	28	(	72	48	H	104	68	h
41	29	)	73	49	I	105	69	i
42	2A	*	74	4A	J	106	6A	j
43	2B	+	75	4B	K	107	6B	k
44	2C	,	76	4C	L	108	6C	l
45	2D	-	77	4D	M	109	6D	m
46	2E	.	78	4E	N	110	6E	n
47	2F	/	79	4F	O	111	6F	o
48	30	0	80	50	P	112	70	p
49	31	1	81	51	Q	113	71	q
50	32	2	82	52	R	114	72	r
51	33	3	83	53	S	115	73	s
52	34	4	84	54	T	116	74	t
53	35	5	85	55	U	117	75	u
54	36	6	86	56	V	118	76	v
55	37	7	87	57	W	119	77	w
56	38	8	88	58	X	120	78	x
57	39	9	89	59	Y	121	79	y
58	3A	:	90	5A	Z	122	7A	z
59	3B	;	91	5B	[	123	7B	{
60	3C	<	92	5C	\	124	7C	
61	3D	=	93	5D	]	125	7D	}
62	3E	>	94	5E	^	126	7E	~
63	3F	?	95	5F	_	127	7F	<DEL>

Extended ASCII Characters								
DEC	HEX	Character	DEC	HEX	Character	DEC	HEX	Character
128	80	€	171	AB	«	214	D6	Ö
129	81		172	AC	¬	215	D7	×
130	82	,	173	AD		216	D8	Ø
131	83	f	174	AE	®	217	D9	Ù
132	84	„	175	AF	¯	218	DA	Ú
133	85	…	176	B0	°	219	DB	Û
134	86	†	177	B1	±	220	DC	Ü
135	87	‡	178	B2	²	221	DD	Ý
136	88	^	179	B3	³	222	DE	Þ
137	89	‰	180	B4	´	223	DF	ß
138	8A	Š	181	B5	µ	224	E0	à
139	8B	‹	182	B6	¶	225	E1	á

Extended ASCII Characters (Continued)								
DEC	HEX	Character	DEC	HEX	Character	DEC	HEX	Character
140	8C	Œ	183	B7	·	226	E2	â
141	8D		184	B8	¸	227	E3	ã
142	8E	Ž	185	B9	¹	228	E4	ä
143	8F		186	BA	º	229	E5	å
144	90		187	BB	»	230	E6	æ
145	91	‘	188	BC	¼	231	E7	ç
146	92	’	189	BD	½	232	E8	è
147	93	“	190	BE	¾	233	E9	é
148	94	”	191	BF	¿	234	EA	ê
149	95	•	192	C0	À	235	EB	ë
150	96	–	193	C1	Á	236	EC	ì
151	97	—	194	C2	Â	237	ED	í
152	98	˜	195	C3	Ã	238	EE	î
153	99	™	196	C4	Ä	239	EF	ï
154	9A	š	197	C5	Å	240	F0	ð
155	9B	›	198	C6	Æ	241	F1	ñ
156	9C	œ	199	C7	Ç	242	F2	ò
157	9D		200	C8	È	243	F3	ó
158	9E	ž	201	C9	É	244	F4	ô
159	9F	ÿ	202	CA	Ê	245	F5	õ
160	A0		203	CB	Ë	246	F6	ö
161	A1	ı	204	CC	Ì	247	F7	÷
162	A2	ç	205	CD	Í	248	F8	ø
163	A3	£	206	CE	Î	249	F9	ù
164	A4	¤	207	CF	Ï	250	FA	ú
165	A5	¥	208	D0	Ð	251	FB	û
166	A6	¦	209	D1	Ñ	252	FC	ü
167	A7	§	210	D2	Ò	253	FD	ý
168	A8	¨	211	D3	Ó	254	FE	þ
169	A9	©	212	D4	Ô	255	FF	ÿ
170	AA	ª	213	D5	Õ			

## Code Page Mapping of Printed Bar Codes

Code pages define the mapping of character codes to characters. If the data received does not display with the proper characters, it may be because the bar code being scanned was created using a code page that is different from the

one the host program is expecting. If this is the case, select the code page with which the bar codes were created. The data characters should then appear properly.

<b>Code Page</b>	<b>Standard</b>	<b>Description</b>
1	CP ISO646	
2 (Default)	ISO 2022	Automatic National Replacement Characters
3	CP Binary	
51	ISO 8859 1 51	Western European Replacement Characters
82	ISO 2022 11 Swe	Swedish Replacement Characters
83	ISO 2022 69 Fra	French/Belgium Replacement Characters
81	ISO 2022 25 Fra	French/Belgium Replacement Characters
84	ISO 2022 11 Ger	German Replacement Characters
85	ISO 2022 11 Ita	Italian Replacement Characters
86	ISO 2022 11 Swi	Swiss Replacement Characters
87	ISO 2022 11 UK	British Replacement Characters
88	ISO 2022 11 Dan	Danish Replacement Characters
89	ISO 2022 11 Nor	Norwegian Replacement Characters
90	ISO 2022 11 Spa	Spanish Replacement Characters
91	ISO 2022 85	Spanish Replacement Characters
92	ISO 2022 16	Portuguese Replacement Characters
93	ISO 2022 84	Portuguese Replacement Characters
94	ISO 2022 60	Norwegian Replacement Characters

# Unicode Key Maps

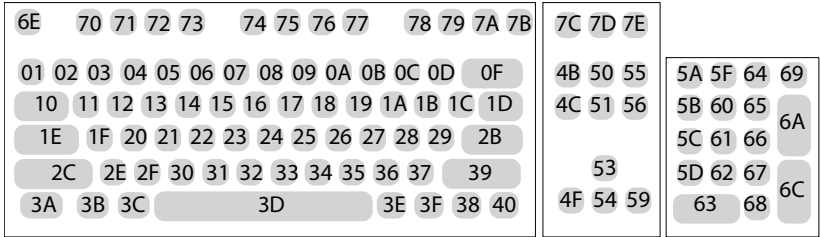

104 Key U.S. Style Keyboard

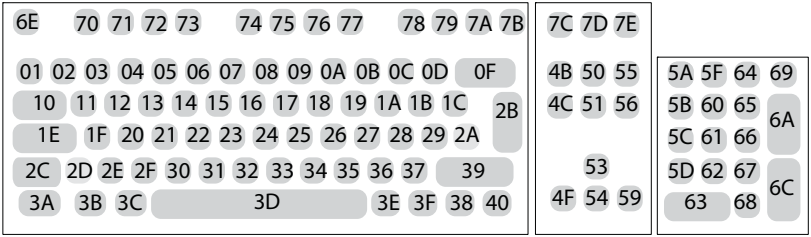

105 Key European Style Keyboard

---

# Sample Symbols

**UPC-A**



0 123456 7890

**Interleaved 2 of 5**



1234567890

**Code 128**



Code 128

**EAN-13**



9 780330 290951

**Code 39**

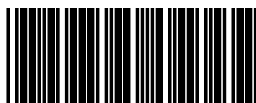

BC321

**Codabar**



A13579B

**Code 93**



123456-9\$

**Straight 2 of 5 Industrial**

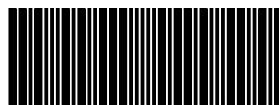

123456

---

---

# Sample Symbols

**Matrix 2 of 5**



6543210

**GS1 DataBar**



(01)00123456789012

**PDF417**



Car Registration

**Postnet**



Zip Code

**Data Matrix**



Test Symbol

**QR Code**



Numbers

**4-CB (4-State Customer Bar Code)**



01,234,567094,987654321,01234567891

**ID-tag (UPU 4-State)**



J18CUSA8E6N062315014880T

---



---

# Sample Symbols

**Aztec**



Package Label

**Micro PDF417**



Test Message

**MaxiCode**

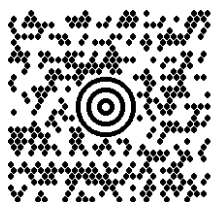

Test Message

---

---

# Programming Chart



K0K

0



K2K

2



K4K

4



K6K

6



K8K

8



K1K

1



K3K

3



K5K

5



K7K

7



K9K

9

---

---

# Programming Chart



KAK

A



KCK

C



KEK

E



MNUSAV.

Save



RESET\_.

Reset



KBK

B



KDK

D



KFK

F



MNUABT.

Discard

*Note: If you make an error while scanning the letters or digits (before scanning Save), scan Discard, scan the correct letters or digits, and **Save** again.*

**Honeywell Scanning & Mobility**

9680 Old Bailes Road  
Fort Mill, SC 29707

[www.honeywellaidc.com](http://www.honeywellaidc.com)